

60
April
1988

elektor

INDIA

155
Rs. 8.00

electronics

SENSORS AND ACTUATORS

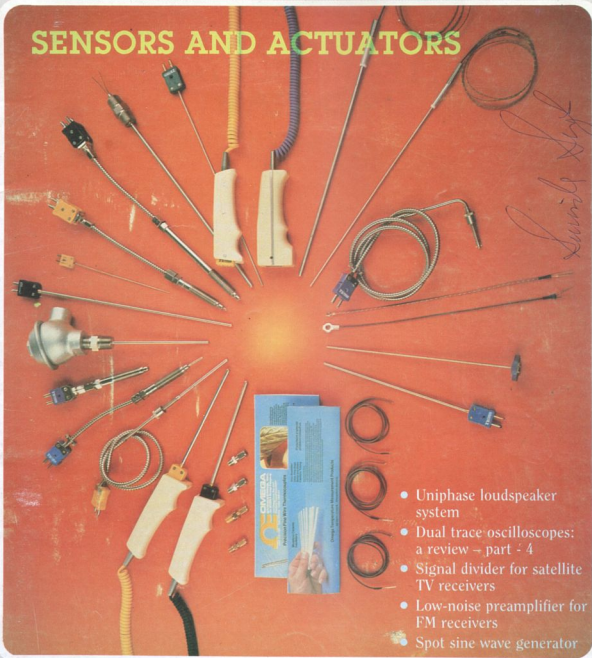

- Uniphase loudspeaker system
- Dual trace oscilloscopes: a review - part - 4
- Signal divider for satellite TV receivers
- Low-noise preamplifier for FM receivers
- Spot sine wave generator

DO IT YOURSELF

THE

JUNIOR COMPUTER

BOOK IS HERE

LEARN-BUILD-PROGRAM

the practical introduction
to a powerful system

Price
Rs. 50.00
Available at
all leading
book shops.

The Junior Computer book is for anyone wishing to become familiar with microcomputers, this book gives the opportunity to build and program a personal computer at a very reasonable cost.

The Indian reprint comes to you from

elektor DIGITAL

Send full payment by
M.O./I.P.O./D.D. No Cheque Please.
Packing & Postage free

to: **elektor ELECTRONICS pvt ltd.**
52-C, Proctor Road, Grant Road (E),
Bombay-400 007.

JUNIOR COMPUTER

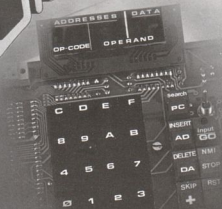

Publisher: C. R. Chandarana
Editor: Surendra Iyer
Technical Editor: Ashok Dongre
Circulation: J. Dhas
Advertising: B. M. Mehta
Production: C. N. Mithagari

Address:
ELEKTOR ELECTRONICS PVT. LTD.
52, C Proctor Road, Bombay-400 007 INDIA
Telex: (011) 76661 ELEK IN

Overseas editions:

Elektor Electronics
1, Harlequin Avenue,
Great West Road, Brentford TW8, 9EW U.K.
Editor: Lee Seymour

Pultron Publicações Técnicas Ltda
Av Itoranga 1100, 9º andar CEP01040 São Paulo — Brazil
Editor: Juliano Barsali

Elektor sarl
Route Nationale, Le Seux, B.P. 53
592270 Baileul — France
Editors: D R S Meyer;
G C P Raedersdorf

Elektor Verlag GmbH
Susterfeld-Strasse 25, 100 Aachen — West Germany
Editor: E J A Krempelsauer

Elektor EPE
Karaiskaki 14, 16673 Voula — Athens — Greece
Editor: E Xanthoulis

Elektuur B.V.
Peter Tiekensstraat 2, 4
6191 VK Beek — the Netherlands
Editor: P E L Kersemakers

Ferreira & Bento Lda
R.D. Estafania, 32, 1º 1000 Lisboa — Portugal
Editor: Jorge Goncalves

Ingelek S.A.
Piaza Republica Equador 2, 28016 Madrid Spain
Editor: A M Ferrer

In Part:
Kedron Holdings PTY Ltd, Cnr Fox Valley Road &
Kugle Street, Wahroonga NSW 2076 — Australia
Editor: Roger Harrison

Electronic Press AB
Box 63
182 11 Danderyd — Sweden
Editor: Bill Cedrum

The Circuits are for domestic use only. The submission of designs of articles of Elektor India implies permission to the publisher to alter and translate the text and designed and to use the contents in other Elektor publications and activities. The publishers cannot guarantee to return any material submitted to them. All drawings, photographs, printed circuit boards and articles published in Elektor India are copyright and may not be reproduced or imitated in whole or part without prior written permission of the publishers. Patent protection may exist in respect of circuits, devices, components etc. described in this magazine. The publishers do not accept responsibility for failing to identify such patent or other protection.



MEMBER

Printed at: Trupti Offset.

Bombay - 400 013

Ph. 4923261, 4921354

Copyright © 1988 Elektor B.V.



Surendra Iyer

CONTENTS

Components

Sensors & actuators	4.20
The reason for miniature transducers	4.25
Infra-red detector for alarm systems	4.29

Computers

PROJECT: Universal Multiplexer	4.55
--------------------------------------	------

General Interest

Non-inverting integrator	4.32
Room thermometer	4.57

Audio & Hi-fi

PROJECT: Uniphase loudspeaker system	4.33
The value of silence	4.37

Radio & Television

PROJECT: Signal divider for satellite TV receivers	4.26
PROJECT: Low-noise preamplifier for FM receivers	4.44

Test & Measurement

Dual trace oscilloscopes: a review (Part 4)	4.40
PROJECT: Spot sine wave generator	4.48

Information

Telecommunication news	4.16
Electronic news	4.17
New products	4.62

Guide lines

Switchboard	4.67
Corrections	4.74
Index of advertisers	4.74

Selex-33

The megaphone	4.58
---------------------	------

NOT A BAD DEAL, INDEED!

The 1988-89 budget proposals of the Union finance ministry predominantly favoured the farmers and the agriculture sector. Next followed the beneficiaries in textiles. Then followed noteworthy concessions to the electronics industry. Irrespective of the possible discontent among some sections of the electronics sector, the budget proposals positively aim at promoting this industry. Whether these sops are enough can be a matter of debate and indeed, it has been one, even before and after the budget.

Computer industry and software sector have not been ignored either. Surely, the government would expect a positive response from the Indian electronics industry by passing on the budgetary benefits to the consumers. This would also lead to better offtake of products and improved performance by electronics units.

Perhaps, the notable negative feature of the budget is the proposal to increase the excise duty on colour television sets by Rs.250. The rider that it is applicable for sets costing more than Rs.5000 does not mean much because it is hard to find a CTV for less than Rs.5000. This again reminds consumers of the government's promise that CTV will be made available for Rs.5000. But, this is still not a reality.

In all, the budget is not a bad one. Something offered by the government is better than nothing. The ball is now in the court of electronics industry.

Front cover

In line with our theme of the month, our front cover this month shows a selection of thermocouple temperature sensors.

Permanent C-Dot

The Union government has approved the second technology mission of the Centre for Development of Telematics. The technology mission II is estimated to cost Rs.32 crores and it will be completed by 1990.

The government has also decided to make C-DOT a permanent body to undertake futuristic technology missions. The third mission will be devoted to exporting the technology developed by C-DOT. The exports would be made to developing countries which faced similar problems as India.

The objective of mission II is to ensure commercial production of technologies developed by the C-DOT so far. C-DOT has transferred the technology to at least 13 units both in the private and public sector to manufacture PBX and Rural electronic exchanges.

The second objective of the mission will be to develop the Integrated Services Digital Network (ISDN). This is a sophisticated technology, which is still in its infancy in many western countries. According to C-DOT, this technology would be relevant for the rural network in India for the multiple data and voice transmission. Work on this futuristic technology would reduce India's dependence on imports at a later date.

By the end of 1990, C-DOT's 512-line MAX is likely to be ready for commercial production. Field trial of this system is in progress and the software problems are expected to be solved in one year.

Meanwhile, the Union finance minister in his budget speech, paid compliments to C-DOT. "In the field of communications I must share with the House a sense of pride in the work of the Centre for Development of Telematics. By developing a state-of-art electronic switching system, C-DOT has demonstrated what we can achieve through proper organisation and marshalling of our scientific talents. I am allocating Rs.1873 crores for 1988-89 for the department of Telecommunications, an increase of 44 per cent over the outlay for 1987-88", the minister stated.

Recasting Dot

The Union cabinet has referred the proposal to reorganise the Department of Telecommunications (DOT) to an empowered committee of secretaries. This has been as a sequel to objections raised by a number of other departments to various suggestions contained in the proposal.

A high-level committee headed by secretary to DOT, Mr D.K. Sangal, had recommended the setting up of a Telecom Board like the Railway Board. The board was to have six members of the rank of secretaries to the government. The Telecom Commission was to have 15 members, headed by a chairman, enjoying the powers of a cabinet minister.

A separate budget for telecom as in the case of the railways, powers to the board to make imports directly without approaching the department of electronics and the directorate general of technical development and control over the telecom industry were among the controversial proposals which elicited negative comments from other departments.

The finance ministry has not approved the idea of having a separate budget for telecom. The department of electronics would not allow direct imports and full control over the telecom industry to the proposed board. The empowered committee is believed to be engaged in reducing the differences of opinion among the various departments. The DOT itself would be willing to dilute some of its proposals to get approval for establishing a Telecom Board.

Meanwhile, the DOT has worked out a plan to decentralise the giant public sector unit, Indian Telephone Industries. Under the plan, the general managers of four units of the ITI will have financial powers and each unit will have separate balance sheet and profit and loss account. Now, the performance figures of all the units are pooled to assess the performance of the ITI.

The ITI board will have four members instead of the present two.

Telex Shock

Telecommunication Revolution is already upon us. New type of communication systems may have to be imported to participate in the revolution. At the same time innovation is also possible and essential. It takes long time to create facilities public data networks, electronic mail and overseas data communication. Should we wait for imported systems? Can we innovate systems to be in the telecom race? Yes. There are certain interim solutions which are technically attractive, says Dr S. Ramani, director of the National Centre for Software Technology, Bombay.

Already existing services like the telex can be put to new uses, according to Dr. Ramani. For example, it is far more effective

to send a telex than it is to hand deliver a letter or note within metropolitan cities like Bombay or Delhi. If you think of making a phone call, you have to do it yourself. But a telex in your name, costing just one rupee, is a fast, personalised, attention-getting communication.

In the western countries, this has created a "Telex mail shock". Because the telex gets priority over mail in all offices, business communications are sent by telex from word-processors, suddenly increasing the number of telexes received by everyone ten-fold. The companies which use telex in this way surely have an edge over those which do not. Telex has become an important medium in India too as everywhere else because one-day delivery of airmail is still a concept and the speedpost and courier services cost much more than the airmail.

Dr Ramani compares a computer without a datalink to a car without an engine. Hundreds of computer users in India have flocked to data links. The two types now available in India are the dial-up link through a standard telephone link and the telex interface. The dial-up data link works practically on any telephone in most places in India and it is good mainly for communication within a city. Those having several offices in a city can share data using such dial-up data links.

Computer interfaces to the telex network are used worldwide. The National Centre for Software Technology would soon acquire such a facility. Dr Ramani had to send 48 telexes within Bombay to telecom specialists, announcing a special talk by a visitor which was arranged at a short notice. If there was a telex interface to the computers, this work could have been done in 10 minutes instead of five hours it actually took.

Electronically telex exchanges in places like Bombay offer a facility called "group addressing". These exchanges enable the despatch of same message to eight different parties at one stroke. Even those who do not have a computer and telex interface can avail of this facility. The person should, however, be a telex subscriber. The other condition is that the address should be given in such a common way like "All members, managing committee, ABC" and so on instead of personalising the address.

Dr Ramani rightly reminds us that in our penchant for progress we forget the advances already made. Electronic telex machines were available in India since 1986. It has been estimated that these

TELECOMMUNICATION NEWS • TELECO

machines failed only one-fifth the number of times the old, electromechanical machines failed. The electronic machines give more readable copy. They allow the operator to enter messages in memory, get draft copies and send multiple copies without retyping.

While preparing for an international conference, Dr Ramani's office used electronic mail abroad through telex. Most authors had "mailboxes" on a commercial network in North America. "We would just send them what looked like telex at a given number. This would be stored in a computer in the recipient's city in his electronic mailbox. The recipient would dial that computer once in a while, typically twice a day, from wherever he or she was, home of office, using a personal computer, equipped with a dial-up modem and read our messages. The person would type out a reply on the spot and it would turn up within minutes on our telexes. With a telex interface on your office computer, you can have a mailbox too, to read from wherever you

are", explained Dr Ramani.

Another interesting idea emerged from this experience. We can reach people who had no telex or mailbox, using telex. Telex companies in North America have telex numbers in many cities for this purpose. Send your letter, addressed to your person, through the nearest such public telex number. At no extra cost, they take out the telex and put it in postal mail, usually reaching the addressee the next day.

There is no reason why India cannot have a similar facility. Using good quality paper, pre-printed attractively to identify the service, one could receive letters in every city in India on announced telex numbers. Even now, you can generate telegrams from your telex machine, but the service mentioned above will be free of telegraph delays, as it will be typed out at the receiving city at the moment of transmission itself. It will use the telex network rather than the telegraphy network for the transmission.

Japanese have fewer telex connections than Indians. They talk to each other, not in English, but in their own script. As a result, they use facsimile a lot more. Facsimile is in India now. It is ideal for communication using a number of scripts. Letters can be sent in facsimile, whether it is in Hindi, Marathi or Gujarati.

India will get the taste of many new developments in 1988, when out Public Data Network, Vikram, is commissioned. It will enable every office computer in India to get connected with the others at reasonable cost. It will bring electronic mail in a big way. News business oriented services will become available. A lot of trade and business will get done through electronic media. Vikram will vastly improve overseas datacom, making it more practical and cheaper.

The world is evolving new standards for data and telecom networks. The Integrated Services Digital Network, ISDN, is the new dream. It will offer many new facilities to the users.

ELECTRONICS NEWS • ELECTRONICS N

Approach CBI

The Centre for promotion of imports from developing countries (Centrum tot Bevordering van de Import-CBI) is an agency of the Netherlands' ministry of foreign affairs. The objective of the agency is to help extend the range of products and services imported from developing countries to industrialised nations, notably the Netherlands and to boost the economies of developing countries. The CBI sponsors participation in select international trade fairs and exhibitions in The Netherlands.

The purpose of CBI-sponsored participation is to support producers and traders from developing countries when entering the Netherlands market for the first time. The CBI offers marketing, technical and financial assistance to the participants to establish business contacts and to find outlets for their products or services.

The CBI pays for the stall construction and maintenance, return flight ticket to a representative of the participating company, handling charges for the exhibits

and marketing assistance. Application for sponsorship is open to both private sector companies and public sector organisations.

The applicant company should have no regular exports to The Netherlands of the products for which assistance is sought.

Further details can be obtained from: Centre for the promotion of imports from developing countries, P.O. Box 30009, 3001 DA Rotterdam, The Netherlands. Phone 010-4130787 Telex 27151.

Future, not Fiction

What lies in future for humanity is not easy to predict. As many fear the doomsday, serious scientists or futurologists envisage a world of tomorrow which may look like science fiction stuff but science fiction had indeed presaged many future scientific developments. We get a sample of the future from the US chamber of commerce publication, "Nation's Business"

Space stations will serve as gateways for further exploration of the solar system.

A manned scientific station will be set up on the moon. Preparations will begin for a manned mission to Mars.

The X-30 experimental airplane will fly in the early 1990s, setting the trend for hypersonic transport that will hop from New York to Tokyo in less than three hours. Cars will be highly computerised, solar-powered and their life will be 25 years.

Electromagnetic inductive coupling systems buried under the surfaces of main streets will power buses. As buses cruise along they will charge on-board storage batteries so that they can travel on non-powered streets too.

For scientific research into subatomic particles, an 80 km long "superconducting supercollider" will be built which will enable the creation of conditions as it existed just a microsecond after the creation of the Universe.

New ultralight, ultrastrong materials will be developed. Great potential exists for superconductors.

Rapid development of power sources like nuclear fusion and solar electricity

will make energy shortages a thing of the past.

Weather can be modified, hurricanes defused, cloud covers generated over scorched areas and rain brought to deserts.

Geneticists will be reshaping forms of life amazingly, yielding tastier foods and eradicating some of the afflicting diseases.

American business will spend hundreds of billions of dollars on automation that will help them stay in competition. Robots will aid in performing everything from shipbuilding to heart surgery. Automation and other changes may eliminate about 50 million US factory, office and retail jobs in two decades. More jobs will be opening up in services and electronics.

The birthrate in the world now is 150 a minute and the world population has crossed five billion. By the turn of the century, it will cross six billion and could reach 10 billion 30 years later.

What will a typical retailing operation be like 10 years from now? A manufacturer of say, video recorders will buy advertising time on cable television in a different city every day. Families in the city will phone in tollfree orders, paying by credit card. Orders will go straight to the factory which will run round the clock. As video recorders roll off the assembly line they will be boxed, automatically labeled and loaded on the delivery trucks for delivery in the target city the next day.

Communications will undergo tremendous changes. Computers and other devices will be driven by and respond in voices. Marketing surveys indicate 60 per cent of US homes will have computers by 1995 as against 18 per cent now. Fastest growth in services is expected to be in the information sector.

Medical services will climb up. There will be a surplus of physicians in 1990s. Doctors will pay more attention to patients' time. But, they won't go back to the home visit, abandoned decades ago. Instead families will receive much medical advice through home communication centres. The expert system in which speciality knowledge is packed into a computer programme, will find many applications in medicine. Home computers will have phone and video connections with medical expert systems as well as with live physicians.

The concept of doing office work from home may not catch on as the cultural

value of the office, the opportunity to meet and work with other people in a diverse environment, will remain strong. Thanks to automation, a 20-hour week may become common by the turn of the century. People will be working much more from cars fitted with computers that recognise speech and can talk back.

Whether these predictions come true or not, the British author John Galsworthy's words justify such an exercise "If you do not think about the future, you cannot have one".

Assam Electronics

The government of Assam is giving special attention to the development of electronics industry in the state by extending increased rate of different subsidies. Under this policy, electronics industry gets power subsidy at 60 percent, infrastructure subsidy of 35 percent and 75 percent subsidy on the cost of drawing power lines.

Mr Digen Bora, Assam's industries minister, stated that this subsidy was far higher than the subsidy offered to other industries. He was inaugurating the first top of the line colour television, Amtron Connoisseur, produced by the Assam Electronics Development Corporation.

According to Mr D. Kakoti managing director of Amtron, the company was engaged in the production of telecommunication equipment too besides consumer electronics Amtron has been given the Rs. 1.50 crore EPABX project of 20,000 lines per year and another Rs.1 crore rural automatic exchange project of 10,000 lines per year.

Amtron has signed an agreement with ITI, Bangalore, to manufacture 300,000 push button telephones per year, under ITI brand name. Under this Rs.10 crore project, two plants will be set up at Guwahati and Silchar. Amtron will also set up in cooperation with the government of India a Rs. 2 crore electronic test and development centre near Guwahati.

Regional Offices

The department of electronics will set up its offices in different regions of the country soon, especially at Calcutta, Bombay, Bangalore and Madras. According to Mr K.P.P. Nambiar, secretary, the department would finally establish cells in all state capitals.

Mr Nambiar also announced at Calcutta recently that the government was in the process of establishing "radio shacks" which would be a chain of retail outlets

for electronic components, thus ensuring regular supplies to small scale industries. The Electronics Trade and Technology Development Corporation (ET & T) has been entrusted with the job of establishing these outlets.

ET & T was also keen on setting up the outlets in collaboration with the state electronic corporations. This has already been done in Orissa and Maharashtra. The government would also permit the private sector to set up such shops, according to Mr Nambiar. Besides, the government would also set up 10 design centres before the end of 1988. These centres would design printed circuit boards and make chips as well.

Exit Kit Culture

The planning commission has called for urgent policy measures to discourage the "kit culture" in electronics industry. This is to conserve foreign exchange and promote genuine indigenisation.

The import bill in the first two years of the seventh plan period exceeded Rs.2000 crores which is more than 60 per cent of total output in the electronics sector in the country. The planning commission has noted that the growth in electronics has been confined to consumer and computer segments. However, there will be a shortfall in the production targets in the segments of communications, components and industrial electronics, which should form the backbone of the Indian electronics industry.

A comprehensive national microelectronics programme has not yet been formulated. A good linkage between Semiconductor Complex Ltd. with consumers in the country is yet to be established. The user sector continued to rely on foreign suppliers for LSI and VLSI chips.

Boosting Export

The commerce ministry has identified a number of products in the electronics sector to boost exports. The products fall in categories such as consumer electronic components, communication, software, consultancy services, and test and measuring instruments.

In 1986, export earnings from electronics amounted to Rs.240 crores against Rs. 154.50 crores earned in the previous year. In 1975, the exports were worth a meagre Rs. nine crores while by 1990, the figure is expected to touch Rs.1000 crores.

The commerce ministry and the depart-

ment of electronics will coordinate their efforts to maximise foreign exchange earning through exports.

The items identified on the basis of existing export potential are: radio cassette recorders, colour and black and white TV sets; black and white TV picture tubes, ferrites, pre-recorded audio cassettes, transformers, plastic film, mica and electrolytic capacitors, carbon film, metal film resistors, and cast alloy permanent magnets; direct reception sets, EPABX and two-way radio communication equipment, personal and microcomputers, peripherals and eight-bit microprocessors.

The seventh plan aims at achieving an annual production level of Rs. 10860 crores in value terms by 1989-90 with emphasis on export promotion in electronics. The break up of the production target is: components Rs.2100 crores; consumer electronics Rs.2000 crores; communication Rs.3100 crores; broadcasting Rs.240 crores; aerospace and defence Rs.540 crores; central instrumentation and industrial electronics Rs.2010 crores; and computers and office equipment Rs.870 crores.

The estimated figures for electronics export by 1989-90 are: electronic components and subassemblies Rs.300 crores; computer, control systems and instruments Rs.170 crores; computer software, systems engineering and consultancy Rs.300 crores; communication, broadcasting including consultancy Rs.65 crores; aerospace and defence electronics Rs.25 crores; consumer electronics Rs.1000 crores, including video films and feature films worth Rs.140 crores.

Meanwhile, the Reserve Bank of India has sanctioned foreign currency loans to software exporters, thus giving green signal for the Exim Bank to launch its software export scheme, announced a year ago. The Exim Bank has so far sanctioned Rs.10 crores as loans to software exporters to import hardware and to make local purchases to meet the export orders. The bank has cleared six applications by January, 1988.

Budget proposals

The Union finance minister, Mr N.D. Tiwari, made the following proposals concerning electronics while presenting the budget for 1988-89:

We have been using the fiscal mechanism for some time to give a boost to the entire electronics sector. As a re-

sult of the government policy, substantial growth has taken place in this sector, giving employment to lakhs of young men and women.

At present, concessional rates of customs duty of 60 per cent or 70 per cent ad valorem are available in respect of specified items of machinery for the electronics industry. With a view to providing a stimulus and keeping in view the latest advances in technology, a uniform concessional duty of 60 per cent ad valorem is extended in respect of 280 items of machinery for the electronics sector.

Customs duty on moulds, tools and dies required by the electronics industry is being reduced further from 60 per cent to 30 per cent ad valorem.

The coverage of the graded structure of duties for raw materials, piece parts and components for the industry is being enlarged. Polycrystalline silicon will now bear a lower duty of 35 per cent instead of the existing 80 per cent.

Machinery and instruments required for the manufacture of Rural Automatic Exchanges based on indigenous technology will attract a lower duty of 30 per cent. A uniform rate of 100 per cent is being provided in respect of a large number of equipments for telecommunication transmission, satellite communication, switching, data communication terminals, television transmission, studio and sound broadcasting. Non-electronic components of these equipment will bear a lower duty of 80 per cent. With a view to encouraging production of high-tech items like LSI circuits, microprocessors and other micro-electronic items, import of 22 items of machinery will be allowed at 15 per cent ad valorem.

At present, computers, computer systems and peripherals attract varying rates of duty from zero to 147.5 per cent. As a rationalisation measure, a uniform rate of duty of 80 per cent ad valorem plus countervailing duty is being provided in respect of all computers, computer systems, computer peripherals and spare parts. Software will continue to attract the existing rates of customs duty of 60 per cent ad valorem.

As an export incentive, accompanying computer software and start-up spares imported under the policy on computer software export, software development and training will be allowed at the rate applicable to hardware. Computerised numerically controlled systems and their parts at present attract a customs duty of 80 per cent. This is being lowered to 55

per cent ad valorem. Excise duty on CNC systems is being reduced to 50 per cent ad valorem.

Colour TV sets of screen size exceeding 36 cms and of assessable value exceeding Rs.5000 per set will now attract an excise duty of Rs.2000 instead of Rs. 1750. However, such sets of value not exceeding Rs.5000 will continue to attract a duty of Rs.1500 per set as at present.

Excise duty on audio magnetic tapes is being enhanced to Rs.4 per square metre. Blank audio cassettes are being exempted from duty. Excise duty on computer software is being reduced from 25 per cent to 10 per cent ad valorem.

The proposed budgetary allocation for the year 1988-89 for the department of electronics is Rs.120 crores against the revised estimate of allocation for 1987-88 of about Rs.126 crores.

Among the major recipients of funds are: National Informatics Centre Rs.31.50 crores; Centre for Advanced Studies in Electronics Rs.1.70 crores; Generation of special manpower for computer Rs.2 crores; Centre for Development of Telematics Rs.5.50 crores; Indian Microelectronics Programmes Rs.4 crores; Manufacture of computer mainframes Rs.8 crores; Society for Applied Microwave Electronics Engineering and Research Rs.4.70 crores; Centre for Electronic Design and Technology Rs.4 crores; National Radar Council project Rs.2.50 crores; and Fifth generation computer System development programme Rs.4 crores.

SENSORS & ACTUATORS

Radiant, mechanical, thermal, magnetic, and chemical effects in our environment are nowadays normally detected and measured by electronic means. The conversion of these (analogue) effects into (digital) electrical signals is invariably effected by sensors. These transducers have become so important that without them life on earth would almost literally come to a standstill.

Sensors come in a wide variety: it is estimated that there are close to 20,000 different types produced by thousands of manufacturers all over the world. The most important types are used in the detection or measurement of temperature, pressure, gases, radiation, humidity, magnetism, acceleration, direction, angle, flow, level, presence, position, displacement, and many more.

The operation of most sensors depends on optics (lasers, optical fibre, infra-red emitters and detectors), semiconductor (photo transistors, photo diodes), thermoelectricity (thermocouples), or piezoelectricity.

The demands made on most sensors are high: they must be sensitive, corrosion-resistant, inexpensive, precise, stable, easily integrated into a microelectronic circuit, and preferably have a linear input/output characteristic.

Optic sensors

Fibre optic sensors can be regarded as comprising three parts: the optical transmitter, the optical modulator, and the optical receiver. Each of the three parts has one major "active" component. The transmitter has an emitter (such as the LED or a laser); the modulator has the stimulus sensor mechanism (such as a diaphragm or a specific optical property material); and the receiver has a photodetector.

The emitters employed in fibre optic sen-

A **sensor**, the popular name for transducer, is a device that converts a non-electrical parameter into an electrical signal or vice versa. The variations in the electrical signal parameter are a function of the input parameter.

Most transducers provide a linear, analogue output, but some provide a digital output in the form of discrete values. Most transducers are linear devices, i.e., they provide an output that is a linear function of the input.

Like many networks, transducers may be considered as quadrupole devices, but one pair of terminals is not necessarily electrical.

Most transducers require external electrical excitation for their operation; exceptions are piezo-electric, photovoltaic, and electro-magnetic sensors.

An **actuator** is a device that converts an electrical signal into another form of energy, normally mechanical. It is thus a special type of transducer. Typical examples are loudspeakers, electronic switches, and many measuring instruments.

sors can be classified as broadband (incandescent), narrowband (LED), coherent (lasers), or blackbody radiators (emitting from inside or outside the fibre). The choice of which one to select depends solely upon the modulator mechanism being employed. For in-

stance, fluoroptic thermometers use temperature dependent fluorescence of materials at the end of a fibre optic probe. Many sensors for high temperature measurements rely upon blackbody radiation for ranges from 300 to 2000 degrees Celsius. However, the vast majority of applications use their own external light sources in the form of an LED or a laser, primarily because of the specific need to accurately control the emitter wavelengths, power outputs, and modulation frequencies.

Fibre optic sensors have been helped significantly by developments in LEDs, super luminescent diodes (SLDs), and lasers used in the fibre optic communications and optical disc industry. Semiconductor LEDs can emit from either their surfaces or their edges, depending upon their design. Surface emitting LEDs (SLEDs) have a wide solid angle on the output beam, and the beam intensity is Lambertian. Edge emitting LEDs (ELEDs), on the other hand, have a waveguide mechanism inherent in their structure (as do lasers) and thus have a narrower Gaussian intensity beam.

An SLD lies midway between an LED and a laser. It possesses only a single pass gain. As the current density is increased, even though an SLD shows a greater (super) luminescence than an LED, it still does not reach the threshold for multiple pass gain. However, because light is designed to undergo a single pass in the active area of the SLD, its spectrum is narrower than the LED's.

TABLE 1.

Comparison of Surface LEDs (SLEDs), Edge LEDs (ELEDs), SLDs, and Lasers

Characteristics	SLED	ELED	SLD	Laser
Spectral width (nm)	80-100	75-80	10-20	0.8-2.5
Spectral optical power output (mW) at 100 mA (except lasers)	0.5-0.75	0.4-0.5	0.6-0.8	5-10
Coupling efficiency of optical power into fibers	Mediocre, needs lensing	Small	Better	Best
Response time (ns)	10-50	5-15	5-15	1-2.5
Stability to ambient temperature	Least changes	Sensitive	Sensitive	Least sensitive
Lifetime expectancy in years	1000	1000	100	100
Package options				
- Lenses	Yes	No	No	Special cases
- Fibre connectors	Yes	Yes	Yes	Yes
- Fibre pigtail	Yes*	Yes	Yes	Yes
- Thermoelectric coolers & stabilization modules	No	Seldom needed	Special cases	For all critical applications

The amount of power an emitter needs to generate for a fibre optic sensor application is a function of several design factors. The power from an emitter must first be transferred into an optical fibre. In many cases, it must be tailored appropriately (e.g., through a polarizer, as in the case of a fibre gyroscope) prior to such introduction.

LEDs, SLDs, and lasers are not only made of the same semiconductor materials but also have the same basic device structure. In principle, these semiconductor devices have a p-n junction, which upon being forward biased leads to a recombination of holes and electrons with the simultaneous emission of photon energy. The wavelength of this emitted light is in turn governed by the composition of the semiconductor material. Thus, the amount of aluminium determines the center wavelength of the emitted light.

LEDs, SLDs, and lasers are in an ascending order of sophistication (see Table 1). An SLD can be regarded as an emitter that is half-way between an LED and a laser. An LED produces spontaneous emission in its "active" region and thus has a wide spectrum about a central wavelength. A laser has a built-in mechanism in its structure so that light produced in its active region is made to oscillate between its specially designed front and back facets, thus leading to a primary wavelength or mode of operation.

An important application of the optic sensor is in robotics, since it makes possible artificial vision, without which robots can not reach their full potential. Another application of the optic sensor is in seam tracking and process control in arc welding. The sensor is inherently insensitive to the arc light.

An interesting application is the oxygen sensor that measures oxygen saturation in the human blood so as to control the rate of a pacemaker. The sensor is integrated in the stimulation catheter and located in the right ventricle of the heart. A new line of intelligent sensors promises to rid cars, buildings, aircraft, and factories of most of the increasingly complex wiring. One of these sensors uses a multiplexable optical encoder chip produced for Honeywell by its Optoelectronic Division in Richardson, Texas. This chip combines sensors and analogue and digital circuits on a single wafer. The on-chip sensors can determine direction or rotation, rotational velocity, and angular position.

A new technique to measure physical correlations in multi-use fluid transportation systems has been developed by the Berg Akademie Freiberg in Federal Germany. In this, fibre optic probes are used to accurately measure particle concentration, fluctuation, speed, size, and cross-sectional distribution — all critical in process control and regulation.

Among the measurement said to be possible with the system are impurities in water, organic or inorganic liquids, gas bubbles in liquids, crystals in saturated solutions, and flocculants in pipes and other apparatus.

Japan's Sofia University has developed an optic sensor that controls on-off switching for use in optical computers. The optical switch needs no electric circuits, since the optical signals are controlled by light beams. Remote control and information exchange are possible. The development is expected to accelerate the development of optical information processing technology, which forms the basis of optical computers and optical communications.

Semiconductor sensors

Semiconductor sensors have two important advantages over other types: they are invariably produced from silicon, which is a plentiful and well-researched material, and they can easily be integrated with amplifier and logic circuits onto a single wafer.

These sensors are normally encountered in the form of photo transistors or photo diodes. A photo transistor is a detector that consists of a bipolar junction transistor operated with the base region floating. The potential of the base region is determined by the number of charge carriers stored in it. The electromagnetic radiation to be detected is applied to the base of the transistor and produces the base current. The transistor is operated essentially in a common-emitter configuration.

A photo diode produces a current when it is illuminated. There are two main classes of photo diode: depletion-layer and avalanche. Depletion-layer diodes consist commonly of a reverse-biased p-n junction operated below the breakdown voltage. The p-i-n and Schottky photodiodes are versions of the depletion-layer type. Avalanche photo diodes are reverse-biased p-n junction diodes that are operated at voltages above the breakdown voltage.

Sensors for the detection of gases are normally manufactured from other semiconductor materials, such as tin oxide, zinc oxide, titanium oxide, and others.

Thermocouple sensors

Thermocouple sensors depend on the phenomenon that when two dissimilar metals are joined at each end and the two resulting junctions are maintained at different temperatures a voltage is developed between them. Copper-constantan or iron-constantan thermocouples can be used up to 500 °C. Temperatures up to about 1500 °C may be measured with the aid of a platinum/platinum-rhodium

alloy thermocouple, and even higher temperatures may be measured with an irridium/irridium-rhodium alloy thermocouple.

Piezoelectric sensors

When certain materials are subjected to mechanical stress, an electrical polarization is set up in the crystal and the faces of the crystal become electrically charged. The polarity of the charges reverses if the compression is changed to tension. Conversely, an electric field applied across the material causes it to contract or expand according to the sign of the electric field.

Piezoelectric sensors are important since they couple electrical and mechanical energy and, therefore, are used as gramophone pick-ups, loudspeakers, microphones, to name but a few.

Practical applications

Temperature sensors. As already mentioned, many temperature sensors are based on the Seebeck effect that occurs in a thermocouple. They are normally produced in the shape of a probe: a wide variety of such probes is shown in Fig. 1.

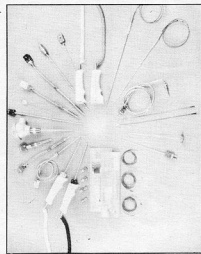

Fig. 1. A selection of thermocouple temperature probes. (Photograph courtesy Omega International Inc.)

Another well-known type of temperature sensor is the thermistor. This is basically a resistor, made from semiconductor material, that has a negative temperature coefficient. This means that when the ambient temperature rises, the element becomes more conductive (its resistance decreases) and the consequent change in voltage across it is a measure of the temperature rise. It should be noted that there are also thermistors with a positive temperature coefficient, whose resistance, therefore, increases when the temperature rises.

Temperature may also be measured by

measuring infra-red (heat) radiation, for which an infra-red sensor as shown in Fig. 2 is used. This technique, called

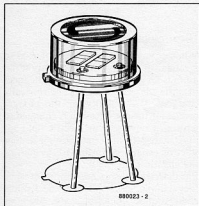

Fig. 2. Typical infra-red sensor.

thermal imaging or thermography, is based on the property that each body or object radiates heat. The technique, for which a camera with a suitable lens system may be used, does not require any external source of illumination. It is used, for instance, in production tests to determine whether any component heats up too quickly (and is, therefore, almost certainly faulty). It is also used in medicine for diagnostic purposes to determine whether any areas of the body have an unusual temperature distribution.

Pressure/force sensors. Although there are various methods of measuring pressure and force, the most common one makes use of the piezoelectric effect as discussed earlier in this article. The most widely used material for the manufacture of pressure/force sensors is quartz. This material has some important advantages over others: (1) it is strong; (2) it is cheap; (3) it is a good electrical insulator so that the electric charge caused by the pressure collapses only slowly.

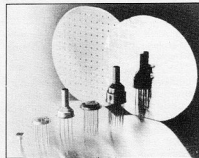

Fig. 3. Constituent parts of a piezo-electric pressure sensor. (Photograph courtesy Telefunken AG).

The parts making up a typical piezoelectric sensor are shown in Fig. 3. It consists of a wafer of silicon only 1 mm in diameter, onto which a tiny piezoelectric

crystal and four resistive tracks have been etched with the aid of ion implantation. When pressure distorts the crystal, the resistance value of one or more of the legs of the resistance bridge changes. This type of sensor is versatile: it can be used for measuring absolute or relative pressure, overpressure, and pressure difference. It is suitable for pressures up to 40 MPa.

This type of sensor is, of course, widely used in all sorts of weighing machine. Other areas of use are hydraulics, water works, refineries, filter plants, pressure chambers, and loudspeakers.

Pressure sensors are also used in accelerometers, but there they operate somewhat differently. Such a sensor for measuring mechanical vibrations or impact contains a freely moving seismic mass and a piezoelectric element (normally quartz)—see Fig. 6. When the seismic mass is accelerated in the direc-

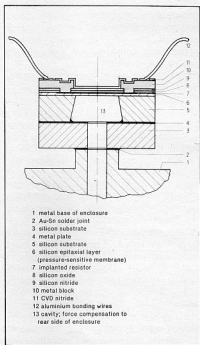

Fig. 4. Construction of a typical piezoelectric pressure sensor. (Courtesy Siemens AG).

tion of its axis, it exerts a force onto the quartz element that is proportional to the acceleration. The element is then distorted and the consequent piezoelectric voltage is used to charge a capacitor. This charge can be measured, but this has to be done quickly as otherwise some of the charge leaks away. At frequencies below the resonant frequency of the sensor, the seismic mass follows the vibrations faithfully. This type of sensor usually contains an integrated preamplifier.

Humidity sensors. Humidity sensors are used almost exclusively in hygrometers,

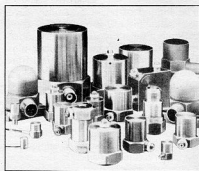

Fig. 5. A selection of typical pressure sensors. (Photograph courtesy Bruel + Kjaer).

i.e., instruments for measuring the humidity of air. In the past, these sensors used a human hair, or a strand of silk, but nowadays they use a capacitor, a dew point mirror, or optical means. The dew point mirror sensor depends on the effect that when a smooth surface is cooled it mists up. The moment this misting up starts is determined optically. Since it is accurately known at which pressure and temperature gases condense, this technique yields very accurate results.

Another type of dew point sensor consists of a very small wafer of resistive material which has been coated with a hygroscopic chemical. The wafer is fitted with two electrical terminals. When mist forms on the coating the resistance of the wafer increases. This type of sensor is quite vulnerable, but because of its very small dimensions, it is used in Sony's 8 mm Camcorder.

Optical humidity sensors make use of the property that gas molecules absorb energy at certain frequencies: water vapour does so in the infra-red region. It is thus possible with the aid of an infra-red sensor to determine how much energy is absorbed. The higher the humidity, the more energy is absorbed. This technique has the disadvantage that the infra-red sensor soils up easily and then becomes unusable.

Nowadays, the most important and best-value-for-money type of humidity sensor

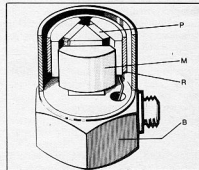

Fig. 6. Construction of accelerometer sensor. M = seismic mass; P = piezo-electric element; B = underside; R = initial tension. (Courtesy Bruel + Kjaer).

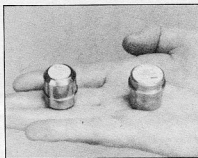

Fig. 7. These twin axis gyros belong to a range of inertial sensors that includes rapid start coasting displacement gyros, rate gyros, Dynamically Tuned Gyros, and linear accelerometers. (Photograph courtesy British Aerospace).

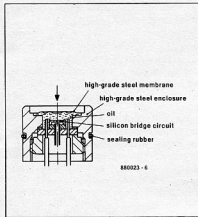

Fig. 8. Construction of a combined pressure and temperature sensor. (Courtesy Sensortechnik Widemann).

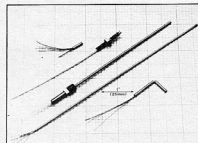

Fig. 9. Selection of EPI Series pressure probes. (Photograph courtesy Entran Ltd).

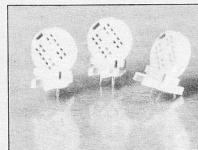

Fig. 10. Some tiny semiconductor humidity sensors. (Photograph courtesy Valvo Philips).

is based on a capacitor. This is, of course, a special capacitor which as a dielectric that is sensitive to humidity. In the Valvo sensor—see Fig. 10—the dielectric is in the form of a foil that has been coated at both sides with gold, which forms the electrodes. Humidity changes the dielectric constant of the foil and thus the capacitance of the capacitor. Since this capacitor forms one of the legs of a capacitive bridge, the change in capacitance can be readily converted into an electrical voltage.

Gas sensors. As stated before, gas sensors are normally based on a variety of semiconductor materials. Such materials have the property that their resistance decreases when certain gases are present in the surrounding air. This effect is caused by adsorption of gas molecules on the surface of the semiconductor material. The consequent layer of gas molecules influences the conductivity, and thus the resistance of the element. These sensors are very sensitive: concentrations of only 1 ppm of the relevant gas in air are readily detected.

A variant of this type of sensor is Telefunken's ISFET—see Fig. 12. Basically, this is a modified MOSFET in which the usual metal gate has been replaced by a layer that reacts to the ions of certain gases. ISFETs are unbreakable, small, have a low-impedance output, have a large linear range of operation, are temperature compensated, and provide an output signal that is suitable for driving a microprocessor. Many gas sensors still depend (and will continue to do so) on a chemical reaction to generate an electrical voltage, current, or resistance change. Yet other sensors use the heat generated by the combustion reaction when a gas hits the surface of the sensor. This heat is applied to a platinum wire whose resistance then changes.

There are also optical gas sensors and these are used particularly for the detection of fire or smoke. They normally use a photo diode or photo transistor to monitor the light absorption behaviour of the surrounding air. When smoke darkens the air, the photo transistor switches off and this operates an appropriate actuator.

Light sensors. Popularly probably the best known type of sensor is the light sensor. This can be based on a photo diode, photo transistor (see Fig. 13), p-i-n diode, photo varistor, or solar cell. All of these are made from the same material, silicon, and function in similar fashion at wavelengths from about 400 nm to around 1000 nm. Photons enter the silicon and cause a number of electrons to jump to a different energy level. This in turn causes a photo current which can be used to operate an actuator.



Fig. 11. Some typical gas sensors. (Photograph courtesy Drägerwerk AG).

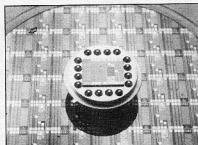
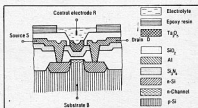

Fig. 12. The ISFET is a modified MOSFET used as a gas sensor. (Courtesy Telefunken AG).

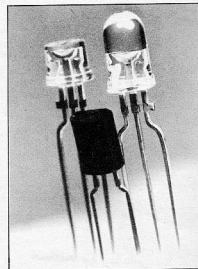

Fig. 13. Some typical photo transistors with in the centre an infra-red photo diode.

For wavelengths below 400 nm (ultra-violet light), photomultipliers are used. These are normally constructed as a valve and have the usual advantages of electron tubes: good bandwidth, low noise factor, high amplification. Primary electrons, emitted from the

cathode as a result of photon bombardment, are accelerated by the field between anode and cathode and arrive at the anode with great energy, causing a current in the anode circuit. The anode current is much greater than the original cathode current, whence the name photomultiplier.

Photo detectors as described were also used as light sensors in camera tubes, but nowadays they are largely superseded by CCD (charge-coupled device) sensors, particularly in video cameras, medical cameras, and robotics. CCDs are small: typically, one the size of a 28-terminal IC has a resolution of 60,000

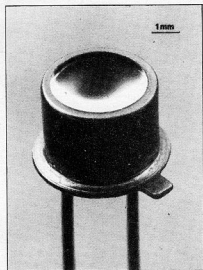

Fig. 14. Photo diode used as a gas sensor. (Photograph courtesy Plessey Semiconductor).

elements. Each of these elements consists of a photo diode with a light-sensitive area of only a few micrometres. Each photo diode is accompanied by a MOS capacitor that stores the generated photo electrons. The charge on the capacitors is read at regular intervals by a shift register. Suitable circuits integrated on the device process the information to a suitable level for driving a microprocessor.

Biological sensors. During the past few years, a new type of sensor has entered the fields of biology and medicine. These so-called biosensors consist of biological molecules, such as enzymes and antibodies. When such sensors react to other substances, a small electric signal is generated that can be detected with the aid of a suitable electrode (probe).

Remote sensing. Another interesting new field where sensors are indispensable is that of remote sensing. This exciting new technique has been made possible by the routine availability of satellite information for the entire surface of the earth. Remote sensors on board satellites provide digital data in seven wavebands of visible light, reflected infra-red radiation, and thermal infra-red radiation. Different surfaces reflect different amounts of radiation, which is why they appear in different colours and light intensities to us. In the same way that we distinguish objects by their appearance (but in a more sophisticated manner), these remotely sensed images can be used to identify the land-cover types which exist in an area. Since they record in the infra-red region, many things we cannot normally see are shown. Crop condition and the thermal properties of buildings or water can be 'seen' and displayed, for instance.

Remote sensing enables scientists to study the earth's surface on a scale which was until recently only dreamed of. For a very small part of the time it would take to survey a large area by conventional methods, digital information can now be used to identify and measure the extent of crop types, major land uses, soils, properties of water bodies, geological structures, and vegetation conditions. In sparsely populated areas, the existence of certain surface features is being established for the first time, and over all areas of the world, what were previously partial surveys can now be completed. A great attraction of remote sensing is the relatively low cost of large-scale surveys. For instance, images with ground resolution down to

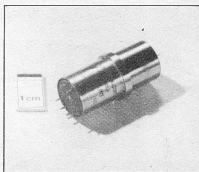

Fig. 15. The DART (Dual Axis Rate Transducer) is a miniature gyro particularly suited for stabilization of laser, infra-red, and radar seeker systems. The sensor, which is only 40.6 mm long and has a diameter of 18 mm, uses a rotating piezo-electric crystal to sense the applied rate. (Photograph courtesy British Aerospace).

10 m and covering 50 km x 50 km can be obtained for less than £1,000.

Much pioneering work on remote sensing has been carried out in Britain by Salford University.

A final thought. Although the science and technology of sensors and actuators has made vast strides in the past few decades, the most complex, reliable, and versatile sensor system remains man. Coupled with his intelligent data processing unit which almost certainly will not be emulated during the life of anyone alive today, he forms a formidable system of intelligence. A pity we do not always appreciate it.

We acknowledge with thanks the co-operation and help received from the following organizations in the preparation of this article: British Aerospace; Bruel + Kjaer; Drägerwerk AG; Entran Ltd; Hawker-Siddeley; IGI Consulting Inc.; Omega International Corporation; Plessey Semiconductor; Salford University; Sensortechnik Wiedemann; Siemens AG; STC Mercator; Telefunken; Valvo Philips.

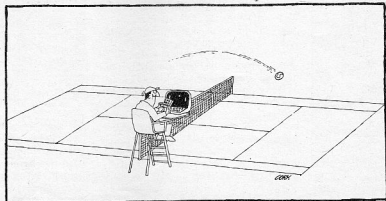

THE REASONS FOR MINIATURE TRANSDUCERS

by Mike Coope*

A statement made by a senior engineer in the aircraft industry recently summed up some of the reasons why many industries have turned towards the use of miniature transducers. "Years ago our aircraft engine control electronics were the size of a small suitcase but today the total package size has been dramatically reduced. This obviously means that when we are testing these components, particularly for important vibration tests, that the additional weight that we add by employing transducers on to the unit can, if the size, and hence weight, are not minimal, completely change the test performance. We must therefore look for transducers, in this particular case accelerometers, with the smallest possible mass".

The simple but important rule that applies here is that $F = m \times a$. Hence the additional force that is applied to the item under vibration test is dependent on the mass and the distribution of mass in the overall dimensions of the transducer. For instance, suppose that a conventional sized accelerometer is used for the vibration test. If it weighs 100 grams and is being used for 100 g acceleration, by calculation in the $F = m \times a$ formula, a further 10 kg is added to the weight of the component under test. This will considerably distort the results of the vibration tests.

Entran designs and manufactures piezo-resistive semiconductor strain gage accelerometers which have the capability of measuring both steady-state dc and high response dynamic vibration inputs. The EGA range offers models with measuring ranges from 0.5 g up to 0.5000 g within a housing as small as $0.140 \times 0.140 \times 0.270$ in. ($3.4 \text{ mm} \times 3.5 \text{ mm} \times 6.75 \text{ mm}$) and weighing as little as 0.5 grams. The EGA Series has the desirable feature of fluid damping to protect against resonant excitation. The EGAX model the additional feature of internal overrange stops which give the accelerometer the capability of accepting an overload of $\pm 10,000$ g in either the normal sensitive acceleration measuring axis, or in all directions. This feature is available even on the lowest measuring range of ± 5 g. Not only will this overrange feature make the accelerometer suitable for many impact and guidance applications, but it will also protect a valuable measuring transducer from day-to-day mishandling on the work-

shop floor where accidents will unfortunately happen.

These particular features of low mass and high overrange of the EGAX accelerometers have proved beneficial to a particular area of research in the medical field. Various departments of Medical Establishments have the need to study the features of muscular tremours and diseases such as Parkinson's disease. With patient involvement, the need is for an unobtrusive and small vibration measuring device to monitor the movements of the patient's limbs that has the capability of withstanding several thousand 'g' should the accelerometer be inadvertently dropped to the floor. This specification exactly fits the Entran EGAX Series of accelerometer, which has been used for many years by several Medical Establishments.

Entran designs and manufactures a variety of semiconductor strain gauges, of which the smallest is active over 0.020 in. (1.50 mm) length by 0.006 in. (0.150 mm) width. The distinct advantage of these resistive sensing elements is (a) their micro-miniature size and (b) their extremely high gauge factors. The term gauge factor (GF) is a measure of the incremental change in the resistance of the strain gauge for a given incremental change in the active length of the gauge, i.e. $GF = \Delta R / \Delta l$. Hence, gauge factor is a measure of the sensitivity or output performance of the strain gauge. To give a comparison, stan-

dard foil strain gauges typically have a gauge factor of 2.0, whereas that for a semiconductor strain gauge can be typically 150. This means that when semiconductor types are used, we can expect improvements of outputs in the region of approximately 75 times. Entran takes full advantage of these properties of their strain gauges in their extensive range of miniature transducers. In the accelerometer (Fig. 1) strain gauges are bonded in pairs to the top and bottom surfaces of a single degree of freedom cantilever beam. A mass is attached to the end of this beam and the resulting deflection of the beam when experiencing a 'g' force results in a linear signal output when the strain gauges are wired into a Wheatstone bridge and an excited voltage is applied (Fig. 2).

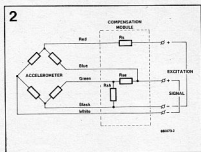
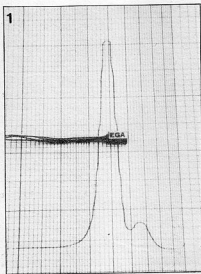

The advantages of strain gauge properties are also used in miniature pressure transducers (Fig. 3) where the parameter is sensed by monitoring the deflection of a metal diaphragm. To achieve the highest possible dynamic response, the diaphragm must be small and its designed full scale deflection minimal. With their inherent high sensitivity and ultra-miniature size, semiconductor strain gauges can be used on a stiff, low deflection diaphragm to achieve this criterion. A further advantage of the miniature diaphragm is its low deflection, resulting in low stress levels within the diaphragm material, and hence almost infinite fatigue life. Thus Entran pressure transducers offer measurement of both static and high frequency dynamic inputs.

The smallness of pressure has an important bearing on their performance. Size can also be important on the overall effects of the test. For instance, in the testing of the aerodynamics of scale models of new military and civil aircraft, automobiles, aircraft components such

as helicopter blades, missiles, and generally all transport where the efficiency of movement is important, the transducer must be as unobtrusive as possible so as not to alter the original shape of the test piece. Entran have ultra-miniature transducers of low profile designs (EPL) with a thickness of 0.040 in. (1.02 mm), which are used in a recessed mounting to give original aerodynamic flow lines of the test model. Alternatively, all Entran EPI pressure transducers are available with diameters from 0.080 in. (2.03 mm) down to 0.050 in. (1.27 mm) and are used in many wind tunnel tests because they can be easily accommodated within the rivet head of an aircraft structure without affecting the structure and pattern of the normal air flow.

Entran's specialization is in the design and manufacture of miniature transducers for the measurement of acceleration, pressure, load and strain, but many other models have been developed with the requirements of Entran's customers in mind. Although standard models exist, it is accepted that many

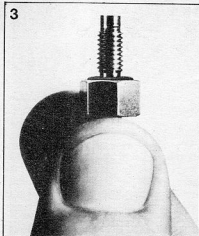

transducer requirements fall outside the normal specification and, for these situations, Entran has special engineering facilities to provide the low-cost OEM style transducer or the ultra-sophisticated, latest-technology, quality-assured transducer.

Within this framework of adaptation to market requirements, Entran offer a range of accelerometers and pressure transducers which are the outcome of long experience of transducer design. The new range of devices offers robust styling, both internally and externally, as well as the optional addition of internal miniature electronic circuits to give (a) amplified output up to 10 V FS; (b) supply regulation; (c) custom filtering. This short article emphasizes a few of the aspects that miniature transducers can play in the latest fields of industrial, research, medical, aerospace, chemical, automotive and many other industries. Further information on ENTRAN sensors may be obtained from ENTRAN Ltd • Sales & Technical Centre • 5 Albert Road • CROWTHORNE RG11 7LT • Telephone (0344) 778848 • Telex 847422 • Fax (0344) 777991.

* Mike Coope is Technical Sales Director of Entran Ltd.



SIGNAL DIVIDER FOR SATELLITE TV RECEIVERS

by R. van Terborgh

Our first application of a monolithic microwave integrated amplifier (MMIC) from Avantek is a wideband amplifier and splitter that makes it possible to connect two satellite TV receivers to a single outdoor unit. In other words: this is your chance to share the cost of a dish plus LNB with your next-door neighbour!

As stated in the introductory article on MMICs (reference ⁽¹⁾), these new devices are eminently suited to building high performance wideband amplifiers with only a handful of components. In the present application, a single MMIC is used for amplifying the IF output signal of a commercially available low noise block down converter (LNB or LNC). The standardized IF bandwidth of LNBs is 950—1750 MHz, but it should be noted that these are not absolute band edges. Most LNBs have a relatively high conversion gain (55 dB typ.), but this is often found to decrease with frequency. Similarly, the attenuation of the download coax cable increases with frequency, so that the highest down-converted transponder signals are almost invariably of lower absolute amplitude than those further down in the IF band, while C/N figures are still roughly the same because reduced gain results in less noise (compare the S-meter reading of Super Channel to that of, say, Teleclub Switzerland).

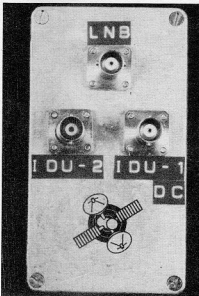

The foregoing observations have consequences for the design of a cable amplifier/signal divider for use in satellite TV receiving systems:

1. The amplifier should have a relatively high drive margin to prevent it being "blocked" by the high output levels supplied by the LNB.
2. The frequency response of the amplifier should be as flat as possible across the entire IF band.

Both requirements are met by the proposed amplifier/splitter based on the Type MSA0404 MMIC, which ensures an output power of +12 dBm at 1 dB compression, and a third-order intercept point of +26 dBm (0 dBm \approx 1 mW in 50 Ω).

The 2-way signal divider described here provides a modest, but often welcome, insertion gain of about 4 dB on both outputs, and allows relatively inexpensive coax cable to be used for connecting the indoor units. Still, do not be tempted

into using, say, 30 m RG-58, or ubiquitous "TV coax": the massive attenuation such a cable introduces is impossible to overcome by the best cable amplifier or IDU input stage. Stick to good quality COAX12, COAX6, or H43 cable (all 75 Ω), terminated in BNC, N or F connectors. Green or yellow coax cable occasionally seen in TV and radio distribution networks is also suitable, but appropriate plugs may be difficult to obtain.

Circuit description

The circuit diagram of Fig. 1 shows the single-chip amplifier and 2-way signal divider. The LNB is connected to BNC, N or F socket K_1 ; the 2 indoor units (IDUs) to K_2 and K_3 . Amplifier IC1 is a Type MSA0404, whose technical characteristics can be found in Fig. 5 in (1). Gain of the MMIC is 8 dB; input and output impedance are 50 Ω . The mismatch between the 75 Ω cable and the 50 Ω input of the amplifier (K_1 ; MMIC), is of no practical consequence (reference (2)).

The amplified wideband signal is applied to a resistive splitter, R_2 - R_3 , for feeding to the indoor units. Given the amplification of the MMIC, and the loss in the splitter, the net gain on each channel is still about 4 dB (do not forget that the MMIC has a 50 Ω output, and that K_2 and K_3 are terminated in 75 Ω). More gain is not desirable here because it would lead to overdriving of the input stage in the IDU.

Output K_2 on the amplifier/splitter accepts the LNB supply voltage carried on the download coax cable to the IDU. This supply voltage is also used for powering the MMIC via R_1 - L_2 , and appears on K_1 after passing through chokes L_3 and L_1 . Indoor unit 1 (IDU 1) connected to K_2 powers the LNB and the signal divider. The supply voltage on the coax cable should not disappear when IDU 1 is switched off, because this would make reception on IDU 2 impossible. The *Elektor Electronics* indoor unit (reference (3)) causes no problems in this respect: the LNB supply voltage is present on the RF input as long as the unit is connected to the mains, i.e., irrespective of the position of the ON/OFF switch.

Capacitors C_2 , C_3 , C_6 and C_7 ensure adequate supply decoupling, while C_1 , C_4 and C_5 are DC blocking capacitors with a low reactance and stray inductance at the frequencies involved.

Series resistor R_1 should be dimensioned in accordance with the LNB operating voltage supplied by the IDU on the download coax cable. The MMIC draws about 50 mA at the recommended supply voltage of 5.5 V, so that

$$R_1 = (V_{LNB} - 5.5) / 0.05 \text{ } [\Omega].$$

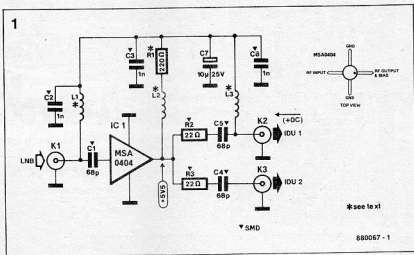

Fig. 1. Circuit diagram of the wideband amplifier and splitter for satellite TV receivers.

The value of 220 Ω shown in the circuit diagram ensures safe operation of the amplifier when connected to the *Elektor Electronics* IDU ($V_{LNB} = 15$ V).

Warning: some indoor units supply an LNB voltage as high as 18 V or even 24 V. Always measure V_{LNB} on the centre tip of the RF input connector of your IDU with the LNB connected to the download coax cable. Then calculate R_1 as shown above.

The dimensioning of R_1 is not critical: calculate the theoretical resistance, select the next higher value from the E12 series, measure the voltage on the RF OUT/BIAS terminal of the MMIC, and decrease the resistor value if required, until the operating voltage is between +5 V and +6 V. Be sure to use an ordinary 1/2 W carbon film resistor: its inductance is essential in this application.

Construction

Prepare the small Eddystone enclosure shown in the photographs prior to starting any soldering work. Study the locations of K_1 , K_2 and K_3 on the PCB before drilling the holes for these flange-type BNC sockets, which are fitted onto the lid as shown in Fig. 3. You may have to provide new mounting holes on the PCB if you intend to use Type N or F sockets instead of BNC. Mount a suitable clamp to the box to enable attaching this near, or onto, the dish aerial stand, if this is the most favourable location for the splitter considering the lengths of the download cables. Provide lettering on the lid to rule out any likelihood of erroneous connections.

Now proceed with the completion of the printed circuit board shown in Fig. 2. Less experienced constructors should note that all parts, with the exception of

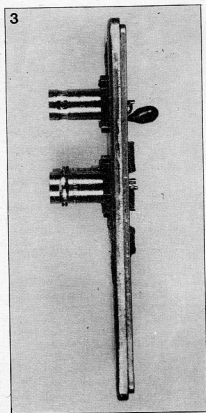

Fig. 3. Side view of a prototype of the signal divider, showing the PCB and the RF connectors secured onto the lid of a diecast enclosure.

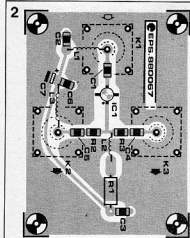

Fig. 2. The small, double sided, printed circuit board for the signal divider is available ready-made through *Elektor Electronics'* Readers Services.

ATTENTION

**PCBs
& Set of COMPONENTS**

for projects are normally available with

precious[®] ELECTRONICS CORPORATION

52-C Proctor Road, Bombay-400 007 Phones: 367459/369478

Parts list

Note: SMD = surface mount device.

Resistors ($\pm 5\%$):

R1 = 220R; 0.5 W carbon film (see text).
R2, R3 = 22R SMD

Capacitors:

C1, C4, C5 = 68p SMD
C2, C3, C6 = 1n0 SMD
C7 = 10 μ ; 25 V tantalum bead

Semiconductor:

IC1 = MSA0404

Inductors:

L1, L2, L3 = home made - see text.

Miscellaneous:

K1, K2, K3 = BNC socket (flange type).
PCB Type 880067
Diecast enclosure (Eddystone; dimensions approx. 112 x 64 x 30 mm).

the 3 sockets, are fitted *direct onto the track side of the board*. The leads of C7, R1 and the 3 inductors should be kept as short as possible.

The MMIC is seated in a $\varnothing 4$ mm hole, and its 4 leads are soldered straight onto the relevant copper areas. All capacitors, with the exception of tantalum bead type C7, are surface mount devices, secured in place by fast soldering with a low-power iron. The same goes for divider resistors R2 and R3.

The 3 home-made inductors in the amplifier are identical. The winding data are as follows:

L1; L2; L3 = 12 turns $\varnothing 0.5$ mm (SWG25) enamelled copper wire; close-wound; internal diameter: 2.5 mm.

Use a sharp knife to remove the protective PTFE collar around the centre pin where this protrudes from the BNC socket. The 3 sockets are held against the outside of the lid, and the PCB is pushed onto the centre pins that protrude at the inside. Press the PCB firmly against the lid, and push the twelve M2.6 screws through the holes in the PCB. Carefully tighten the screws, and solder the centre pins of the RF sockets onto the copper islands at the track side of the board.

Finally, be sure to terminate output IDU 2 in 75 Ω at all times. In most cases, the attenuation of the downlead cable is high enough to ensure proper termination of the amplifier if IDU 2 is disconnected in the home. If, for some

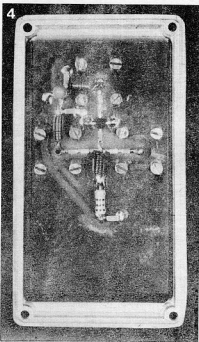

Fig. 4. All parts, with the exception of the RF connectors, are fitted at the track side of the PCB. The small, greyish, rectangular, blocks are surface-mount resistors and capacitors (prototype).

reason, the downlead cable to IDU 2 is temporarily disconnected from the amplifier output, this must be terminated in a 75 Ω dummy load (a 75 Ω resistor fitted in the RF plug). In general, the signal divider should be fitted as close as possible to the LNB/RGK

References:

- (2) Loss encountered when interconnecting cables having the incorrect impedance. By Dr P. Brumm. *VHF Communications*, 3/1974.
- (3) Indoor unit for satellite TV reception, parts 1, 2 and 3. *Elektor India*, November 1986, January 1987, February 1987.

INFRA-RED DETECTOR FOR ALARM SYSTEMS

As a follow-up to the design abstract on the Type PID-11 published last year ⁽¹⁾, this article describes a versatile infra-red sensor which will find many applications in security and alarm systems.

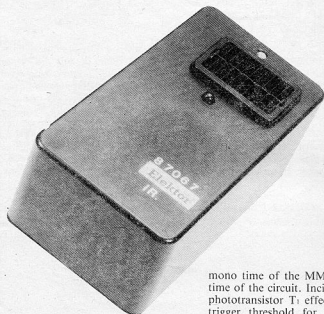

The Type PID-11 infra-red sensor from Siemens introduced in reference ⁽¹⁾ is a versatile component that lends itself to building a simple, yet effective and sensitive, transducer that detects heat emanating from mammals. To be able to understand the basic operation of the circuit shown in Fig. 1, it is recommended to read the sections *Application tips* and *Some suggested circuits* in reference ⁽¹⁾.

The infra-red sensor, IC₂, is powered by a regulated 5 V supply. The reference voltage available on pin 4 (2.2 V) is applied to opamp A₁ for comparison with the voltage at pin 3. The voltage on pin 2 of the comparator is held slightly below the reference with the aid of potential divider R₁-R₂. In the non-activated state of the circuit, the output of A₁ is, therefore, high. When the sensor detects infra-red radiation, however, the comparator supplies a short, low, pulse. Opamp A₂ functions as a monostable multivibrator (MMV) and a buffer whose gain depends on the ambient light intensity measured by phototransistor T₁. The trigger threshold of A₁ can be adjusted with preset P₁. The preset in network C₅-R₃-P₂ at pin 6 of A₂ enables adjusting the

mono time of the MMV, i.e., the hold time of the circuit. Incident daylight on phototransistor T₁ effectively raises the trigger threshold for the MMV, and hence ensures automatic disabling of the alarm by reducing its sensitivity. Pins 5 and 6 of the monostable are logic high in the non-activated state of the alarm. When the PID-11 senses the infra-red

component in heat emanating from a mammal, the voltage on pins 5 and 7 of A₂ drops abruptly to practically nothing. The voltage on C₅ is no longer maintained by D₁, and the capacitor discharges. At the end of the discharge period, the monostable reverts to its initial state. Opamp A₂ supplies a digital (TTL compatible) switch pulse at output DIG. The function of relay driver T₂ and alarm indicator D₂ is self-evident. The maximum on-time of the relay that can be set with P₂ is about 1 minute after detection of any single alarm pulse from the detector.

Construction, adjustment and applications

The printed circuit board shown in Fig. 2 holds all the components in the circuit diagram, and so enables ready construction of the compact detector unit. The completed board is shown in Fig. 3.

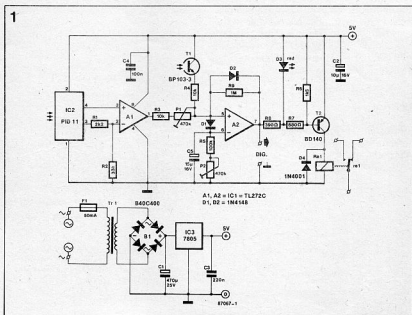

Fig. 1 Circuit diagram of the PID-11 based infra-red detector for alarm systems.

Note that the top of the phototransistor, T_1 , and that of the alarm indicator, D_1 , is level with the top of the PID-11. Relay driver T_2 and regulator IC_3 do not need heat-sinks. The completed board can be fitted in a water resistant, strong ABS enclosure, with suitable grommets, strain reliefs and sockets for the connection of the wires for the relay, the mains, and the digital output, if used.

When the circuit is used as an automatic porch light controller, it is recommended to fit it in a sheltered position over the front door, paying due attention to safe and sound insulation. In many cases, it may be safer (and cheaper) to use a separate 8 V AC adaptor plugged into a mains outlet in the home, rather than the PCB mounted mains transformer, TR_1 .

The adjustment of the circuit, i.e., the sensitivity and the relay on-time, is governed by the application in question. Initially, it is recommended to test the completed circuit by adjusting P_1 such that the circuit is just off in the absence of an infra-red source. For this adjustment, it is necessary to temporarily cover the phototransistor against incident light. The value of tantalum capacitor C_5 may be increased when the maximum relay on-time of 30 to 60 seconds is too short for the given application. It should be noted that the PID-11 signals detection of an infra-red source by an output pulse of about 1.5 s rather than by a continuous logic level. The pulse, which can be measured on the output of A_1 and A_2 , is positive or negative, indicating a cold-to-warm or a warm-to-cold transition, respectively.

When fitting the IR detection unit, it is important to ensure that it can not detect heat from external sources (sunlight, heating systems, etc.). Also note that the sensitivity of the IR detector depends on the ambient temperature. Strong magnetic fields may cause interference in the sensor and hence spurious operation of the alarm. Finally, be sure to avoid overloading the relay contacts by switching too heavy loads. *St*

Reference:

⁽¹⁾ Design abstracts: Passive infra-red detector Type PID-11. Elektor India, April 1987.

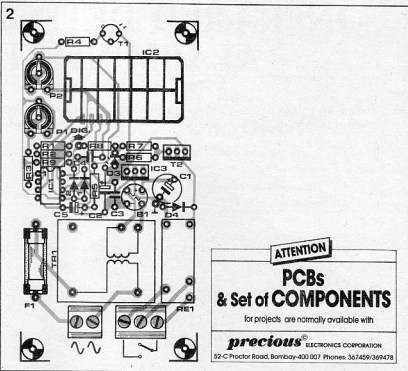

Fig. 2 Track layout and component mounting plan of the PCB for building the IR detector.

ATTENTION

**PCBs
& Set of COMPONENTS**

for projects are normally available with

precious[®] ELECTRONICS CORPORATION

52-C Proctor Road, Bombay-400 007 Phone: 367459/369478

Parts list

Resistors ($\pm 5\%$):

$R_1 = 2K2$
 $R_2 = 33K$
 $R_3, R_4 = 10K$
 $R_5 = 100K$
 $R_6 = 1K5$
 $R_7 = 680R$
 $R_8 = 390R$
 $R_9 = 1M0$
 $P_1, P_2 = 470K$ or 500K preset for horizontal mounting

Capacitors:

$C_1 = 470\mu F$; 25 V
 $C_2 = 10\mu F$; 16 V
 $C_3 = 220n$
 $C_4 = 100n$
 $C_5 = 15\mu F$; 16 V bead tantalum

Semiconductors:

$B_1 = B40C400$ or B40C1000
 $D_1, D_2 = 1N4148$
 $D_3 = \text{red LED}$
 $D_4 = 1N4001$
 $T_1 = BP103-3$
 $T_2 = BD140$
 $IC_1 = TL272C$ or TLC272
 $IC_2 = PID-11$ (Siemens)
 $IC_3 = 7805$

Miscellaneous:

$F_1 = 50 \text{ mA}$ delayed action fuse with PCB mount holder.
 $TR_1 = \text{PCB mount transformer; } 8 \text{ V; } 150 \text{ mA.}$
 $RE_1 = \text{PCB mount SPDT relay; } 5 \text{ V; e.g. Siemens V23127-B001-A101.}$
 2-way PCB mount screw terminal.
 3-way PCB mount screw terminal.
 PCB Type 87067 (available through the Readers Services).

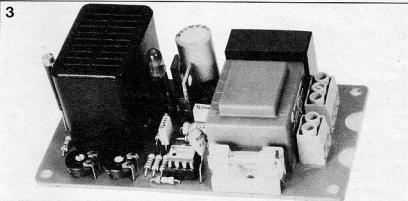

Fig. 3 The completed circuit board ready for fitting in the ABS enclosure.

TOWARDS THE SUPERNODE COMPUTER

by Dr. Chris Jesshope, CEng, FBCS, MIEE
Department of Electronics and Computer Science,
Southampton University

Esprit is a research programme supported by the Commission of the European Communities. It is currently funding a collaborative project to develop and exploit a low cost, high performance supercomputer, in which Southampton University⁽¹⁾ is playing a major role.

Unlike conventional supercomputers, such as the Cray 1 and Cray 2, which tend to use expensive ultra-fast circuits, the prototype being designed at Southampton University makes use of the latest microprocessor technology. The Supernode supercomputer is based on the revolutionary transputer, which is a modern microprocessor designed by INMOS⁽²⁾ as a component of parallel processing systems.

Parallel processing uses many processors to obtain increased system performance. For example, the Supernode supercomputer may eventually contain several thousand transputers, all of which could be brought to bear on a single applications problem. The research programme, as well as developing several prototype supercomputers, will investigate programming and applications techniques for this novel computer architecture.

The exploitation of such large scale parallelism is by no means well established and the United Kingdom, like the rest of Europe, has an active research programme to ensure its information technology industry remains competitive during this period of major change. In fact Southampton University was initially funded by Britain's Alvey programme to investigate the feasibility of using the transputer as a basis for a supercomputer. Other partners in the Esprit collaboration also had prior funding for transputer research.

Prototype production

The collaborators in this project come from Britain and France, and include universities, small and large companies, and a government research establishment. The role of prime contractor with overall project management is filled by the Royal Signals and Radar Establishment (RSRE)⁽³⁾. The remainder of the

plan is divided into work packages which involve the close cooperation of small groups of collaborators.

The prototype designing is being led by Southampton with collaboration from the RSRE and the two industrial partners, Thorn EMI⁽⁴⁾ and Telmat of France. These two will manufacture seven small and four large machines for the work, with commercial exploitation to follow. Provision for real time input and output to the supercomputer is being developed by collaboration between RSRE and Thorn EMI.

The major component of the Supernode supercomputer—also known as the Reconfigurable Transputer Processor—is the newly announced T800 transputer, which was developed within a work package under this collaboration by INMOS.

IMAG at Grenoble University, in France, is working on the system software for the Supernode machine in collaboration with Southampton. They are also studying the implementation of high level languages such as Prolog on this novel

architecture.

The remaining collaborators are working on applications of the supercomputer, including image and signal processing, image generation by ray tracing, computer aided design (CAD) for very large scale integration (VLSI), computer aided manufacture (CAM), and applications in science and engineering.

Transputer development

The T800 transputer is the major component in the Supernode. It is a derivative of the T414 transputer announced by INMOS some two years ago. The major difference between these two chips is that the T800 contains an additional processing unit for handling floating point numbers. Floating point or real numbers may have fractional parts and have a very wide range of values; most microprocessors handle only integers (whole numbers), with operations for real numbers being provided by software, or alternatively by an additional special chip.

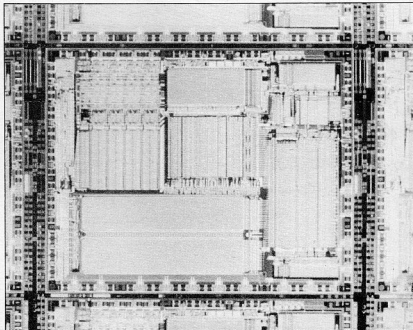

The INMOS T800 transputer chip.

Southampton University identified the limitation of software floating point at an early stage in its feasibility study, based on its applications in science and engineering. This was basically a speed limitation, for it should be noted that all supercomputers provide support for rapid floating point computation and, inevitably, a software implementation will not provide a comparable performance.

The T800 chip is about 1 cm² and contains about 250,000 transistors. Unlike more conventional microprocessors, it can be used entirely on its own as it contains a simple but efficient 32-bit integer processor, the floating point processor which handles numbers stored using up to 64 bits of information, some very fast random access memory (it can store 4096 characters), and four high speed input and output channels.

It is the latter communication channels that provide the key to the transputer's success as a parallel processing component. In any parallel processing system, the processors must be able to communicate with each other, to share data and to synchronise their activity. The communication channels on the transputer provide both of these facilities.

A single channel can transmit about two million characters per second in each direction over the three-wire circuit used to connect transputers together. The four links provide the ability for any transputer to talk to four others directly. This means that transputers could be connected in a regular two-dimensional lattice.

The limitations of such networks are that communications between transputers that are not neighbours will have to be provided by software, with intermediate transputers acting as sorting offices which forward data in conveniently sized packets to a transputer they can talk to but which is closer to the data's destination. Being provided by software, this mechanism is considerably slower than a direct connection.

Powerful workstation

The problems faced in designing the supercomputer all relate to communication, for this is the key to all successful parallel processor designs. Transputers can only have direct connections to four other devices although the sorting office analogy could provide a solution to the difficulty of providing other channels. The problem is that the more transputers are included in the system the slower communication between distant transputers becomes. In programming the supercomputer, what is ideally required is the ability to realize the direct connections between transputers specified by the program.

One of the key features of the Supernode supercomputer is the ability to realize this aim. This is provided by switching circuits on the links. Each transputer has its links connected into a switch through which they may be connected to any other transputer in the system. To provide an alternative analogy, this is similar to telephones when each user (transputer) is connected to an exchange from which he can make a call for a given duration to any other free user connected to the exchange.

In practice, it is expected that the computer will be used with all of the connections established at a given time, providing a pattern of communication or network that reflects the flow of data in the applications program.

One of the disadvantages of using these switching circuits is the cost of the switch, which grows as the square of the number of inputs to the exchange. This cost function is avoided to some extent by designing the computer in modules, each with their own local exchange and of course with lines to other main exchanges. A unit of about 30 transputers can be constructed economically in this way.

This supertransputer, the Supernode, can stand alone as a powerful workstation, or can itself be used as the basis

of a super-supernode. One transputer acts as a supervisor, setting the switches on request. It talks to all other transputers within the node by means of a control bus which is used to synchronise many transputers to a common event, so that the switches may be reset.

The prospects

A single Supernode can contain 32 worker transputers, each containing storage for 256,000 characters, a controller, a memory server with storage for 16 million characters, and a disk server with capacity limited only by disk drive technology. Such a node could perform up to 50 million floating point operations per second, the rate usually obtained from machines such as the Cray 1, a multi-million pound supercomputer dating from 1976.

A Supernode supercomputer could be manufactured for tens or perhaps hundreds of thousands of pounds, and a collection of 32 supernodes in a single supercomputer could produce a proportionally higher performance, in excess of 1000 million floating point operations per second. This is in the same league as today's supercomputers which sell for about £12.5 million. The Supernode supercomputer could be marketed for a fraction of this cost.

References:

1. Southampton University, Department of Electronics and Computer Science, Southampton, United Kingdom, SO9 5NH.
2. INMOS Ltd, 1000 Aztec West, Almondsbury, Bristol, United Kingdom, BS12 4SQ.
3. Royal Signals and Radar Establishment, St Andrews Road, Malvern, Hereford and Worcester, United Kingdom, WR14 3PS.
4. Thorn EMI Research Laboratory Ltd, Dawley Road, Hayes, Middlesex, United Kingdom, UB3 1HH.

non-inverting integrator

A drawback of conventional integrator circuits (figure a) is that the R-C junction is at virtual earth; this means that C appears as a capacitive load across the op-amp output, a fact that may adversely affect the stability and slew rate of the op-amp. Since the non-inverting character of an integrator is of minor importance in many applications the circuit shown in figure b offers a viable alternative to conventional arrangements.

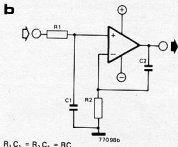
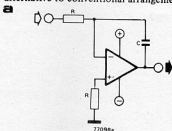

$$R_1 C_1 = R_2 C_2 = RC$$

This integrator, unlike that in figure a, is non-inverting. The time constants $R_1 C_1$ and $R_2 C_2$ should be equal.

If both R_1 and C_1 , and R_2 and C_2 are transposed then the result is a non-inverting differentiator.

For correct offset-compensation R_1 and R_2 should have the same value.

UNIPHASE LOUDSPEAKER SYSTEM

A loudspeaker system that is based on Audax drive units and uses a 12 dB Linkwitz filter. The closed box design enables the drive units to be located in a straight acoustical line.

The use of a Linkwitz filter (Ref. 1) in a loudspeaker system makes sense only if the drive units are positioned in straight acoustical line.

The three-way system presents nothing new, but the drive units have some special characteristics as will be seen later. Total costs for two loudspeakers (drive units, wood, filter components, etc.) is of the order of £250. Listening tests in which the uniphase system was compared with commercially available products show that the quality is roughly the same as that of a commercial system costing twice as much.

The most noteworthy aspect of the box is the staggered front, which is essential to get the drive units in a straight acoustical line. This means that the drive units are positioned in a manner which ensures that the acoustical output of each of the three drivers reaches the listener at exactly the same time.

It might be thought that to achieve this it is sufficient to measure the depth of each cone to be able to calculate by how much each drivers must be displaced with reference to one another. It's a good start, but unfortunately not sufficient. This is because the phase behaviour of each drive unit is far from ideal—see Fig. 1 for a typical phase characteristic of a bass driver in a closed box. Although W. Marshall Leach published a very interesting article on the phase behaviour of drive units in the *Journal of the AES* as long ago as 1980, it appears that in the practical systems of most manufacturers no notice has been taken of the findings of Mr. Leach.

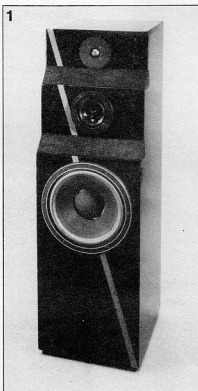

Fig. 1. Prototype of the uniphase loudspeaker system.

In an ideal loudspeaker system $d\phi/d\omega$ must be a constant to obtain optimum pulse behaviour. With reference to the curve of Fig. 1, it is seen that this is virtually impossible to attain. Any box that

contains more than one drive unit and a cross-over filter will have a phase behaviour that causes impulse distortion. Even in a wideband system without filter, it is very difficult to attain optimum impulse behaviour.

Is phase shift audible?

During the past few years, there have been a number of investigations into the question whether phase errors are audible or not. These investigations have failed to agree. It is probable that the sensitivity to phase errors varies from one person to another. And what about the test methods? Our own experience shows that serious phase deviations can definitely be detected in the reproduced sound. Particularly the pronounced phase jumps around the cross-over point of the filter seem to be the culprits. These jumps also cause the loudspeakers to produce a different sound pattern at different positions around the room. This is because the acoustic radiation pattern around the cross-over points shows large variations along its axis.

We have the impression—shared with a number of researchers—that most listeners are not so much sensitive to absolute phase deviations, but rather to sudden phase differences.

A matter of less than an inch

Above resonance, the loudspeaker behaves capacitively at first and then, at higher frequencies, inductively. This behaviour is caused by the voice coil.

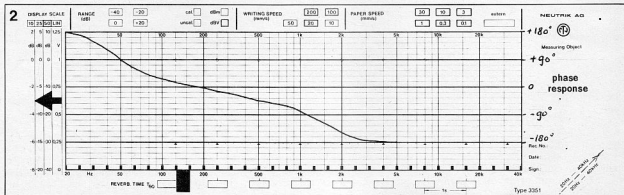

Fig. 2. Phase characteristic of a typical bass drive unit.

The phase behaviour of each driver can be measured with a good standard microphone. On the basis of the results, the drivers are then displaced with reference to one another until their phase characteristics meet smoothly at the cross-over points. This cannot be achieved with 100% accuracy, but the resulting over curve approaches the theoretical one very closely. Fig. 2 shows the overall phase behaviour of the uniphase system after these corrections had been introduced. In practice, the drive units were positioned such that the points of origin of their cones lay in a straight line. This implies that only the specified Audax drivers should be used, since otherwise the distances between the drivers would be incorrect. In other words, if drivers other than the Audax units are used, the phase behaviour must be measured again, and the design of the enclosure adapted accordingly.

Three-way: an acceptable compromise

A loudspeaker system in which account is paid to the phase behaviour and the separation of the drive units cannot very well be realized with fewer than three drivers. Also, the cross-over points should be chosen at other than the standard frequencies. In the present system, they lie at 370 Hz and 3,200 Hz. The latter frequency was chosen deliberately because a middle frequency driver, even if it is small, gives more and more problems with its phase behaviour above that frequency. Moreover, a 25 mm tweeter performs very well at that frequency, particularly if it is remembered that the cross-over points here lie at -6 dB. It should be noted that the distances between the drive units were determined for these frequencies: other values must, therefore, not be used.

The drive units

The bass unit is a 24 cm type on a cast aluminium chassis. The magnet, although of reasonable size, is not particularly large. Since the enclosure is a closed box (which has better impulse behaviour than a bass reflex), the magnet should be not too large to avoid the frequency response characteristic falling off too early.

The middle frequency driver is a splendid unit. To all outward appearances, it looks like a conventional model, but its magnet is the same size as that of the bass unit, and its cone is made of TPX. An aluminium cone in the centre ensures a better spread of the high tones. Its cost is similar to that of the bass unit. It should, however, be borne in mind that this unit takes care of the most important part of the audio range. In our prototype, it performed beautifully.

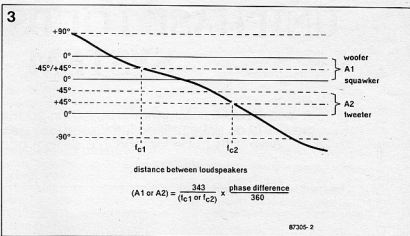

Fig. 3. Displacing the drive units with respect to one another makes the phase characteristics meet more evenly.

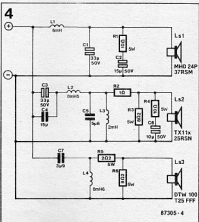

Fig. 4. Circuit diagram of the Linkwitz filter.

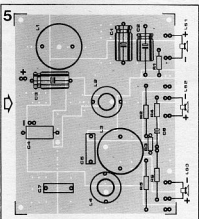

Fig. 5. The Visaton Type UP70/3 PCB and population plan.

The tweeter is a modernized version of a well-established unit, which has formed part of Audax's range for many years. It is, without doubt, still one of the best tweeters available. This version has ferrofluid cooling and damping of the voice coil. It reproduces the very high frequencies with just a little better definition than the original model.

Components list

Resistors:

- (all 5 W)
- R₁, R₄ = 10 Ω
- R₂ = 1 Ω
- R₃, R₆ = 8Ω2
- R₅ = 2Ω2

Capacitors:

- C₁, C₂ = 33 μ; 50 V bipolar
- C₃ = 15 μ; 50 V bipolar
- C₄ = 15 μ MKT or MKC
- C₅ = 5μ6 (4μ7/1μ) MKT or MKC
- C₆ = 10 μ; 50 V bipolar
- C₇ = 3μ9 MKT or MKC

Inductors:

- L₁ = 6 mH (wind on 20 mm pot core from 0.9 mm dia. enamelled copper wire)
- L₂ = 0.5 mH (air-cored; 10 mm dia.; wind from 1 mm dia. enamelled copper wire)
- L₃ = 2 mH (wind as L₁)
- L₄ = 0.6 mH (wind as L₂)

Miscellaneous:

- Bass drive unit: Audax Type MHD24P37RSM
- Middle frequency driver: Audax Type TX11 x 25RSN
- Tweeter: Audax Type DTW100T25FFF
- Synthetic cotton wool wadding (see text)
- Universal filter PCB Visaton Type UP70/3
- Fixing bolts, nuts, and crinkle washers for drive units
- Loudspeaker terminals (4)

The filter

The present system uses a 12 dB Linkwitz filter—see Fig. 4, which is one of the best passive filters. Next month we intend to publish an active version of the loudspeaker system that will make use of the active network published last year (Ref. 2). However, for those who are not

scale : 1 : 7.5

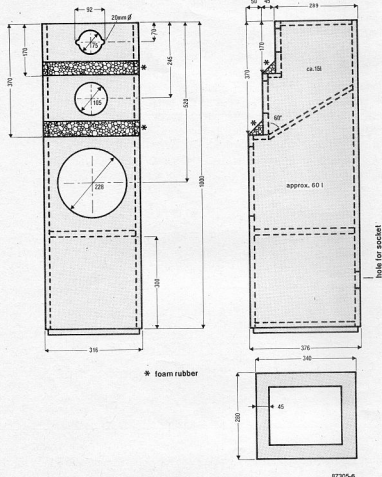

Fig. 6. Construction plan of the enclosure. Required MDF board or chipboard, thickness 18 mm.

prepared to spend the extra money for an active system with six output amplifiers, the passive system is an excellent choice that offers very good sound quality.

The design of the filter follows the earlier article (Ref. 1) fairly faithfully. The increasing impedance presented by the bass unit at higher frequencies is compensated by R_1 and C_2 . A similar network is provided for the middle frequency drive unit, otherwise the filter would not behave as predicted by theory. Furthermore, the middle frequency driver and the tweeter have been given a small attenuation network to match them more closely to the woofer.

The resistances in parallel with the drive units effectively flatten the resonance peak of the impedance characteristic of the middle and high frequency drivers, since these peaks are close to the respective cross-over points.

Readers who check the values of the net-

work components will find that those of C_3 and L_3 do not correspond with the theoretical values. The cause for this discrepancy is that the impedance of the middle frequency unit rises sharply in the vicinity of the cross-over point, in spite of the 8.2 ohm shunt resistor; consequently, during the design it was found that the practical values deviate sharply from the computed ones.

The enclosure

The enclosure is an upright, narrow box of such a height that the middle and high frequency drivers are roughly at ear height. The narrow front keeps the number of reflections to a minimum. As already mentioned, the front surface is staggered to make it possible for the drive units to be placed at the correct distances from one another.

Otherwise, the construction is fairly con-

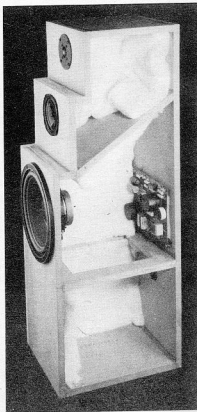
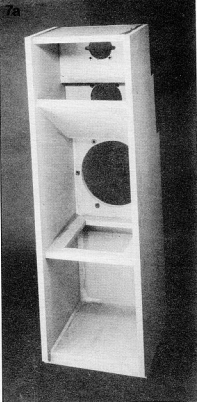

Fig. 7. Some stages in the construction of the prototype.

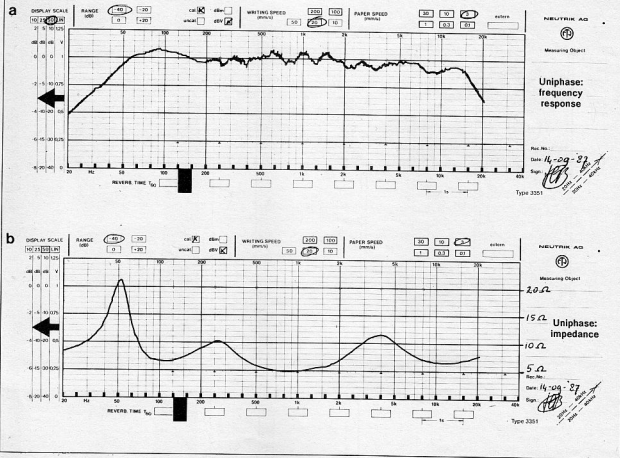

Fig. 8. Frequency characteristic (a) and impedance curve (b) of the uniphase loudspeaker system.

ventional. The volume of the woofer compartment is about 60 l, which is sufficient to obtain a Q_{TC} of 0.7. The -3 dB point of the combination lies at around 45 Hz. The section for the middle frequency unit has a volume of some 15 l. Again, that is necessary to obtain a Q_{TC} for this section of 0.7. Furthermore, it ensures good impulse behaviour over the middle frequency range.

The box is made of MDF (medium density fibre board), a material that resembles chipboard but has a much greater density. If this material cannot be obtained, chipboard of the best quality may be used.

Construction

The filter is constructed on Visaton's Type UP70/3 universal filter PCB as shown in Fig. 5. Some additional holes will have to be drilled in this board. Inductors L_1 and L_2 should be made with a pot core, otherwise they become too large for PCB mounting. All other inductors are air-cored. Capacitors C_1 , C_2 , C_3 , and C_6 are bipolar electrolytic types; all other capacitors are MKT

(metallized polythephtalate) types (MKC—metallized polycarbonate—types are suitable alternatives).

The construction plan for the box is shown in Fig. 6. The panels are interconnected with the aid of suitable dowels and wood glue: bear in mind that the finished box must be airtight. Apart from the panel separating the woofer from the other speakers and the panel halfway up the bass unit compartment, no struts are required.

The drive units are mounted with the aid of nuts, bolts, and crinkle washers. Subsequently, the cables between the drivers and the filter are put in. Take care that the hole in the slanting separating panel through which the cables from the middle and high frequency units to the filter are fed is made airtight after fitting the cables.

The rear of the box is provided with a good quality terminal board.

The filter is mounted on the inside rear panel of the woofer compartment: take care that all cables are connected correctly!

Next, the box is filled with wadding, for instance, synthetic cotton wool which is sold in bags. About 1 bag is needed for

the top compartment and 3 bags for the woofer section.

When all that is done, the box is closed, again using good quantities of wood glue to ensure an airtight closure. Finally, the enclosure is finished to individual taste (cloth, veneer, varnish, etc.).

Finally

The enclosures may be positioned against a wall, but preferable not in a corner.

References:

1. Linkwitz filters; *Elektron India*, May 1987.
2. Active phase-linear cross-over network; *Elektron India*, October 1987.
3. Designing a closed loudspeaker box; *Elektron India*, March 1986.
4. Loudspeaker impedance correction; *Elektron India*, June 1986.
5. Loudspeaker efficiency; *Elektron India*, July 1986.

THE VALUE OF SILENCE

by Dr Dylan Jones and Dr Chris Miles, Department of Applied Psychology, University of Wales Institute of Science and Technology, Cardiff

Most people would agree that their concentration on reading and attempts to memorise information are made more difficult when someone nearby is speaking. One reason stems from the part that hearing has played as a warning system in the course of human evolution. Recent laboratory studies have produced data showing the disruptive effect that speech can have in open plan offices, control towers and even on the flight decks of aircraft, causing serious losses of efficiency. Research is also helping psychologists to chart the flow of information in the brain.

"Under all speech that is good for anything there lies a silence that is better. Silence is deep as Eternity; speech is as shallow as Time."
Critical and Miscellaneous Essays, vol. IV, Sir Walter Scott, by Thomas Carlyle.

Silence is a precious commodity, the more so when we are trying to think clearly or read. Religious orders insist on it for periods of devotion and contemplation. Librarians demand it, too, but are often frustrated by people who insist on whispering.

At our place of work we may find that our ability to understand the written word, or the clarity of our thought processes, is muddled by ringing telephones and the babble of voices in the background. Of all the sounds that impinge upon us, the human voice is especially intrusive; from what is known of the psychology of hearing there are good reasons to suppose that speech is treated in a slightly different way to other sounds.

Abundant anecdotal evidence suggests that the human voice, even when whispered, makes reading difficult; this is true even when the person tries to ignore the sound, so it is clear that speech can intrude without invitation upon our consciousness. Although interference between the written and spoken word is obvious and natural to the layman, it poses a range of significant questions for the psychologist interested in how the brain processes information. First, we must ask why it is that information delivered to two separate sensory organs, the eye and the ear, somehow get mixed in the brain. For interference to occur, the streams of information coming from the two sense organs must share some common pathway in the brain. Part of the psychologist's interest is in locating the precise point at which the interference

takes place. Second, what are those features of speech which make it so difficult to ignore, and why are our strenuous attempts to suppress it usually of no avail?

Disrupting memory

From a series of experiments in various laboratories, a fairly clear picture is beginning to emerge of the way in which ir-

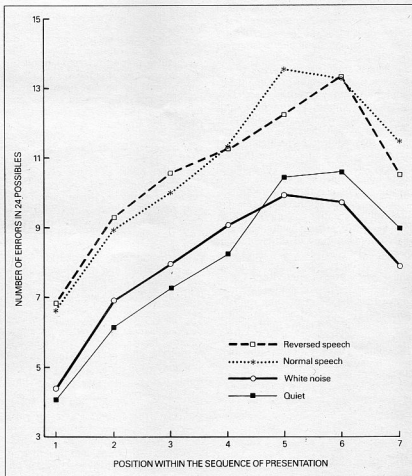

Effects of different types of sound on memory. Speech, even when reversed, is seen to have a more disruptive effect than white noise, which has a similar effect to quiet. This shows that disruption is not simply due to acoustic stimulation.

relevant speech interferes with reading. Studies have proved fruitful for the academic psychologist interested in the workings of the brain and for all those interested in the abatement of noise. Two distinct strands of research on irrelevant speech are discernible: the first examines an effect, now well established in the literature, of irrelevant speech on short-term memory; the second focuses on the more recently discovered effects on the reading process.

Typically, short-term memory is tested by asking a person to recall a list of items such as letters, short words or digits. Each list comprises up to nine items, presented visually at a rate of about one per second. At the end of the list, or soon thereafter, the person is asked to write down the items in the order in which they were presented. The presence of irrelevant speech during the presentation of the items appears to reduce the number recalled by about 20 per cent. By any standards this is a significant degree of impairment. The failure to remember is roughly the same over the whole list; it is apparent only when ordered recall is required, but not when the items can be recalled in any order.

Over the last ten years several features of this disruption have become more clearly understood. First, the loss of efficiency does not depend upon the meaning of the interfering speech; the degree of impairment is similar if the speech is in a language that the person does not understand. Furthermore, reversed speech produced by running a tape backwards through a tape recorder is as disruptive as proper speech. Second, it has been shown that while the intelligibility of speech does not matter, sounds that are not speech do not interfere. For example, white noise (which is a random mix of hissing sounds like those heard from a radio or television set that is not tuned to a transmitting station), is not disruptive. Perhaps this is because white noise and speech are composed of different kinds of acoustic signals. But there is at least one exception to this general finding, which arises from a study we made of the disruptive effect of singing. We have shown that the effect of sung words is similar to that of spoken words. But if the tune is hummed rather than sung the effect is less marked, which suggests that the sound has to be word-like rather than more broadly speech-like. Finally, the intensity of the speech is unimportant: speech as loud as a shout or as low as a whisper disrupts memory to the same degree.

Phonological form

What does this pattern of results tell us about the processes responsible? The findings indicate that the brain mechanism discriminates on the basis of how

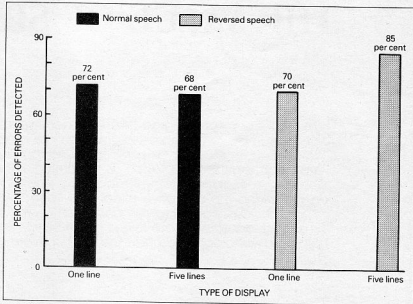

The influence that the number of lines in a visual presentation to a reader has on the effects of irrelevant speech. There is a reduced advantage in viewing the text five lines at a time when normal speech is interfering, but the reader can gain a 15 per cent advantage if the speech is meaningless.

closely the incoming signal approximates to speech. The more similar the sound and speech are to one another, the greater the disruption. However, this mechanism fails to discriminate on the basis of meaning, for the disruption occurs whether the passage heard is meaningful or not. More recent experiments have shown that it is the similarity between the irrelevant speech and the sound of the material being remembered that is crucial. Words which are read are converted into a code which has a sound-like basis, as if the person was producing 'inner speech'. For example, if the list of words has the sounds of *run, new, tree, sore*, in common with irrelevant speech such as *one, two, three, four*, then the disruption will be severe. This points to the possibility that the two streams of information, one originally visual and the other auditory, are converging at a point where they are both held in a so-called phonological form.

The need for this conversion process becomes evident if we reflect for a moment on the way that we read. One way of understanding reading is to think of it as a conversion process from letters and words into sounds, into what we have already referred to as inner speech. When learning to read, the child has to appreciate the appropriate set of rules for converting shapes on the page into this inner speech. Some of the sounds associated with words, and therefore inner speech, may already be known to the child through hearing the language. So hearing and reading share a common level of analysis within the brain. In adult life, whenever we are confronted

with the particularly difficult task of remembering a list of words or letters in the correct order, we make this type of analysis. Intrusion of a similar signal via the ear will lead to confusion; the more similar the codes used in the two streams are, the greater is the confusion when they are stored in memory.

Susceptibility of reading

Another line of our work has focused on the effects that irrelevant speech has on reading. At the outset we suspected that the effects of speech on reading would be different from those on memory. To investigate this possibility we used the technique of playing speech of different sorts while the person was proof-reading a text for spelling and grammatical errors. Typically, a volunteer would spend 15 minutes or so looking for errors which we had deliberately and carefully introduced into the text. We measured how many of these errors they could detect under various conditions of ambient sound.

There are three main features to the outcome of these experiments. First, meaning of the speech in this instance is important. This has been shown by manipulating the speech in a variety of ways. For example, reversed speech produces a roughly similar effect to silence. We were able to confirm this by demonstrating that people bilingual in Welsh and English were disrupted by irrelevant speech in either Welsh or English when they read English text. But the reading of those English speaking readers unable to understand Welsh was

not disrupted by irrelevant Welsh. Second, intensity of speech is not important; just as in the results to do with memory, a whisper has as much effect as a shout. Third, the effect does not depend on other physical features of the speech, such as the number of voices, or whether its source is stationary or moving. The main point seems to be that meaning is important.

Discrete effects

The conclusions from these findings are that it is the meaning of the speech that affects proof-reading. In contrast, short-term memory is affected by speech-like properties of the acoustic signal. So there seem to be two discrete effects, one on reading and the other on memory. We were able to check this by developing a variant of the proof-reading task. We used a computer-based system, in which two forms of the task were developed. In one, a single line of text was displayed. The reader could examine each line and use an electronic pointer to mark errors. When each new line was written-up on the screen the old line was erased, preventing the reader from looking back. The other form displayed the two lines preceding and the two lines following the line under correction. The reader was free to check backwards and forwards. The two versions were used to examine whether reading was being disrupted through reliance of reading on memory. Offering the reader five lines of text necessarily reduces the immediate burden on working memory; the reader may check whether the grammar is correct by glancing back or forward to the entire sentence under scrutiny. In contrast, by providing one line of text only, the reader is forced to remember parts of the sentence while examining it for errors. If reading is disrupted through the effect that speech has on memory, it would be thought that the effect would be more pronounced where the burden on memory is greater. The results of our experiments show just the opposite. The five-line version proved to be more susceptible to disruption. We think that the fluency of reading is important: the more fluent the reading, as with five lines of text, the more likely it is to be disrupted by speech.

Evolution

We are now left with the question of precisely why speech-like sound intrudes into our thoughts. Part of the answer comes from an understanding of the role that hearing has played in human evolution. It has the characteristics of an early warning system and has been described as the sentinel of the senses. It can receive information through the auditory channel in darkness; it can

wake a sleeping person and, unlike the eyes, the ears are omnidirectional. The way we use our eyes is far more purposeful and directed; the ear, in comparison, is a passive and automatic recipient of information. We know, too, that nerves from the ears connect with those parts of the brain to do with alertness. Signals passed on by the ear are far more likely to be significant to a person's survival. All of these features suggest a system tuned to act as a vigilant guardian but one through which, nevertheless, a great deal of intelligent information is transmitted. So speech may take advantage of the ear's guardianship of our consciousness because it can gain privileged access to our thoughts. The next stages of our research will focus on what it is in the nature of the speech signal that determines the degree of disruption. To begin with, this will mean looking at two features of the speech signal, both of which have the potential to interfere. The first is the possibility that speech has a certain combination of sounds, spaced at particular intervals, that characterise speech only. It is likely that the nervous system is tuned to receive such features while rejecting others. The second is that the so-called prosodic features, those increases and decreases in intensity of speech that give it a rhythm of its own, might be responsible. These changes of intensity, which are peculiar to speech, might also be subject to tuning by the nervous system.

Practical outcome

What are the practical implications of our findings? Wherever people are engaged in activities like those we have already described, it seems likely that they run the risk of being distracted by irrelevant speech. Workers in open-plan offices, where there is little or no acoustic isolation, are likely to have their efficiency impaired. Activities such as reading, composing text and performing mental arithmetic are all likely to suffer to some extent.

Most recommendations for the office environment take scant regard of what has already been found out by psychologists. It is usually assumed that the degree of interference by speech is similar to that induced by white noise. That is, it is taken for granted that the interference can be predicted by knowing the ratio of the intensities of signal and noise. But we know that the effect of speech does not depend on its intensity and is therefore largely independent of its distinguishability from background noise. This probably explains the discrepancy that has often been found between objective acoustic measurements in offices and complaints by the people working there.

Control rooms

In any complex system where an operator is exposed to material which has to be read and interpreted, the intrusive effects of speech may be at work. More important is that in control rooms, where streams of speech and text are mixed haphazardly, there is a chance that irrelevant speech will impair the memory of instrument readings and sequences of events. In air traffic control towers and in the control rooms of power stations the intake of visual information is at risk. In these settings, only some of the speech heard will be relevant to the task at hand, so there is good reason to recommend that some kind of control be exercised over incoming spoken messages. In person-to-person communication it could be done by channelling speech via microphones and headphones, so that there is some degree of control over reception.

In control systems using advanced technology, machine-generated speech will be used more and more to pass messages from the machine to the user. Interference from such sources can be kept down by queuing messages within a computer system so that the operator can listen to them at a convenient time when the workload is low enough.

Most profound

It is during the development of reading skills that the effect of irrelevant speech may have its most profound effects. In primary schools the trend has been toward classrooms of the open-plan type. Though data are not yet available, there is every possibility that in such settings fluent reading is being disrupted and the faltering steps of learners are being impaired.

Of all our experimental findings, the single most important is that the disrupting effect of speech is independent of intensity. This means that the traditional idea of abating it ought to be supplanted by eliminating it. Reducing the level of noise by modest degrees is relatively cheap; getting rid of ambient noise altogether is an extremely difficult and expensive enterprise. Yet there may be settings such as the flight deck of an aircraft where the potential costs of disrupting work might be so high that such a course should be seriously considered.

"And silence, like a poultice, comes To heal the blows of sound." The Music Grinders, by Oliver Wendell Holmes.

TEST & MEASURING EQUIPMENT

The penultimate part of Julian Nolan's review of dual trace oscilloscopes deals with the Kikusui COS-5042TM and the Grundig MO22.

Part 1: dual-trace oscilloscopes (D)

Kikusui COS-5042TM

Kikusui are a well-established company producing a range of test equipment that includes signal generators, power supplies, FFT analysers, and a variety of oscilloscopes. Their COS-5000TM range of oscilloscopes extends from a 'basic' 20 MHz model, the COS-5020TM, to the 100 MHz COS-5100TM. The COS-5042TM, the top model in Kikusui's 40 MHz range, costs £715, excluding VAT. The cheapest single timebase 40 MHz scope from Kikusui comes in at £565, excluding VAT. Accessories available include viewing hoods, trolleys, protective front covers, and a suitable camera mount. The two probes supplied with the 5042 are very similar to those provided with other Japanese scopes.

The 5042's small dimensions (288 mm (W) × 150 mm (H) × 370 mm (D)) make its use in conjunction with other instruments in a confined space particularly easy. It is a pity, though, that the 5042 is not provided with a swivel stand, something that with an instrument in this class is normally taken for granted. The one-position stand fitted may be useful if the instrument is to be stacked. The 5042 weighs 7.5 kg.

The 5042 is supplied with a standard IEC style terminated mains lead and can operate from line voltages ranging from 100 to 240 VAC. Facilities provided on the instrument include a trigger holdoff and 3 input channels, the third channel being usable as a trigger view or marker channel. As usual, both the Z-modulation and CH1 output sockets (BNC) are mounted on the rear panel along with, surprisingly, the CH3 position control.

The two main input channels, CH1 and CH2, both have input sensitivities which range from 5 mV/div to 5 V/div, extendable by a ×5 switch to 1 mV/div. A variable control extends the maximum attenuation to approximately 10 V/div. No uncalibrated indicators are provided for the Y-amps which could initially lead to user reading errors, but these should be kept to a minimum thanks to the very clear markings of the variable controls. Input capacitance is reasonable, and cer-



Fig. 19. The Kikusui COS-5042TM oscilloscope.

tainly acceptable, at 25 pF, although input capacitances of 20 pF are becoming increasingly popular on scopes at and above this bandwidth. The bandwidth of both amplifiers is good, extending up to approximately 45 MHz (-3 dB) in the 5 mV/div to 5 V/div ranges and an excellent 23 MHz (-3 dB) when the ×5 magnifier is brought into operation. The ×5 magnifier permits operation in the 2-4-10 sequence against the more usual 1-2-5 sequence, as well as permitting a maximum sensitivity of 1 mV/div. In the ×5 mode, the maximum error is increased from 3% to 5%, in common with most other scopes of this class. As is increasingly the case for scopes of this complexity, only one channel is invertible (CH2) so that in some situations swapping of probes may be necessary. A minimal amount of drift is exhibited by both amplifiers at switch on, enabling accurate measurements to be carried out during the warm-up period without having to resort to adjustments of the Y trace positions after a short period of time.

The third channel is of the same bandwidth as channels 1 & 2, but its ranges are restricted to 0.1 V/div and 0.5 V/div. These are, however, useful in that by the addition of a ×10 probe they can be used for digital measurements, or as a marker channel. In addition, the channel can also be coupled internally, facilitating its use as a trigger view channel capable of displaying the triggering waveform of either CH1 or CH2. All three channels are accurately matched so probes should be fully interchangeable

between them without any compensation adjustments. A 1 kHz 0.5 p-p probe compensation waveform is provided. The wide variety of operating modes provided include the display of CH1, CH2 or CH3 singly or in any combination. Only CH1 and CH2, however, can be added. When in add mode, both the input waveforms can be seen, as well as the resultant which I found to be genuinely useful. The price paid for this versatility is in the ease of operation. Push buttons are used in place of the more usual slider type switches for most of the triggering and mode selection functions. The trigger functions of the 5042 are fairly comprehensive and include auto peak-to-peak triggering, trigger holdoff and an alternate mode. The auto triggering facility worked well in most cases, although it did suffer from a distinct lack of sensitivity over the whole bandwidth. Typical sensitivity was two divisions, which in dual, or triple trace applications can prove to be inadequate. In this case, it is necessary to switch into manual trigger control where the sensitivity is typically 1.2-1.5 div at 40 MHz, or about ½ div at 10 MHz. The trigger holdoff was successful in stably displaying a wide range of waveforms and in some ways made up for the lack of sensitivity. External sensitivity is good at 40 mV (10 MHz) or 150 mV (40 MHz) and its usefulness is extended by a ±5 control, allowing triggering of, for example, only the wanted signal if a large amount of noise is present. The effective 'lock on' time of the auto trigger circuit was good with the minimum of delay present in most cases. Triggering sources include the useful alternate triggering facility, as well as line and, of course, CH1, CH2 or CH3 (Ext). Automatic switching between frame and line synchronization is provided in the TV mode which is surprisingly useful, enabling generally faster and more efficient operation when the scope is operated in this mode. Because of its nature, it did not appear to affect the scope's versatility in any way. An effective HF reject facility is provided, although a corresponding LF facility is not. Triggering facilities for the second (B) timebase, are rather limited,

TABLE 13

ELECTRICAL CHARACTERISTICS

line voltage: — 100,120,220,240 VAC
 $\pm 10\%$, externally adjustable. Power
 consumption: 35 Watts
 Line frequency: 50-60 Hz

MECHANICAL CONSTRUCTION

Dimensions: — W 288 mm, H 150 mm,
 D 370 mm
 Housing steel sheet
 Weight: approx. 7.5 kg

Y AMPLIFIER ETC.

Operating modes: —
 CH1 alone, CH2 alone, or CH3 alone.
 Inversion capability on CH2 only.
 Any combination of CH1, CH2 or CH3
 (alternate or chopped (250 kHz))
 CH1 + CH2
 Frequency response 0...40 MHz
 (-3 dB); 20 MHz $\times 5$ Mag.
 Rise time < 8.8 nsec, t_r : 5 nsec $\times 5$
 Mag.
 Deflection factor 10 steps:
 5 mV/div...5 V/div $\pm 3\%$, vernier control
 adjusts min. sensitivity on 5 V/div
 range to approx. 10 V/div (fully anti-cw).
 CH1 and 2 only.
 $\times 5$ magnifier extends range to 1 mV/div,

20 MHz bandwidth, $\pm 5\%$ = total error
 Input coupling: AC, DC or Gnd.
 Input impedance: 1 M Ω /25 pF; max input
 voltage 300 IDC + peak AC)
 Signal Delay time: approx. 20 ns on CRT
 screen.

CH3 only specifications

Sensitivity: 0.5 V/div or 0.1 V/div $\pm 3\%$.
 Input Impedance: 1 M Ω /25 pF.
 Frequency response: 40 MHz.
 Rise time 8.8 ns.
 Max input: 100 V (DC + AC peak)

X-Y MODE

CH1 and 2 Y-axis, and CH3 X-axis in dual
 channel mode: single channel CH1=X,
 CH2=Y
 Bandwidth: DC to 2 MHz (-3 dB).
 X-Y phase shift $< 3^\circ$ at 100 kHz

SWEEP

Type: — A; A sweep; Alt; A sweep
 (intensified for duration of B sweep); B;
 Delayed sweep; X-Y.
 A sweep time 0.05 s/div to 0.5 s/div,
 $\pm 3\%$ in 22 ranges, 1-2-5 sequence.
 Vernier control slows sweep down by up
 to 3:1
 B sweep 0.05 s/div to 50 ms/div, $\pm 3\%$
 in 19 ranges, 1-2-5 sequence.
 Sweep magnification: $\times 10 \pm 5\%$ ($\pm 8\%$

on 0.05 s/div to 0.2 s/div range)

Holdoff: variable up to 10:1
 Delay modes: trigger delay (Trig);
 continuous delay
 Delay jitter: 1/10000

TRIGGERING

Trigger modes: Auto (bright line), Normal,
 level lock (auto p-p), single-reset.
 Trigger coupling: AC, DC, HF reject, TV
 frame and line (auto).
 Trigger sources: CH1, CH2, Line, Ext. or
 CH3, Vertical (alternate)
 Triggering sensitivity: Internal < 1.5 div
 at 40 MHz, External < 0.15 V p-p at
 40 MHz, Normal mode

MISCELLANEOUS

CRT make: Kikusui, measuring area
 80 mm \times 100 mm; accelerating voltage
 12 kV, domed-mesh type.
 Compensation signal for divider probe,
 amplitude approx. 0.5 V pp ($\pm 3\%$); frequency
 1 kHz.
 Z modulation sensitivity: 3 V (detectable
 intensity modulation)
 Vertical CH1 output: approx 100 mV/div
 into 50. Frequency response: 100 Hz to
 40 MHz except on $\times 5$ (100 Hz to
 20 MHz).
 Covered by 1 year warranty.

although perfectly adequate for most purposes.

The main timebase A, speeds range from 50 ns/div to the usual 0.5 s/div, while the maximum deflection speed can be increased 10 times to 5 ns/div. The second timebase, B, speeds range from 50 ms/div to the same 50 ns/div. An uncalibrated indicator is provided for the A variable sweep control, but not continuously variable control is provided on the B timebase. The display/trigger modes A,Alt,B,B trig should as mentioned above cover most requirements although they are by no means comprehensive. The 5042 offers an 8 trace capability, which consists of CH1, CH2, CH3 and CH1 \pm CH2 on both timebases. To a certain extent, I found this useful, especially for detailed logic comparisons when 3 inputs were being used (6 traces); however, when this was increased to 8 traces, vertical measurements of any accuracy were not possible, as the screen became extremely cramped (1 trace per cm). The timebase accuracy was good across most of the ranges, but at the faster timebase speeds it was noticeable that there was a discrepancy between the two speeds which approached the $\pm 5\%$ specified error (10 magnifier was in operation). A channel 1 out BNC socket is provided on the rear panel giving approximately 50 mV/div into 50.

The 12 kV domed-mesh CRT provides a sharply defined and bright trace across the vast majority of deflection speeds. The brightness of the tube does, however, limit the maximum magnification ratio of the delayed sweep facility to approximately 1000 times in fairly low am-

bient lighting conditions. A front panel control is provided for B trace intensity, which I found to be useful, especially in cases where the delayed sweep facility was used at its higher magnification ratios. A photographic bezel is also fitted, along with a viewing filter.

The 58-page manual starts by giving a general description of the instrument, and goes on to cover operating procedures, application and the specification in some detail. Although a block diagram is provided, no circuit diagram is given, but is available in the service manual.

Internal construction is centred around a number of fibre glass PCBs, the majority of which have their print side facing outwards for easier servicing. There are, maybe not surprisingly, a

large number of wire links, not all of which are grouped together. This could in some cases hinder servicing of the instrument, although I am satisfied that it will not effect reliability. All boards are removable, their connections being made by a number of plugs/sockets. The 5042 is based on a steel frame, which gives it the robustness to operate successfully in a wide variety of environments. In contrast to many other scopes none of the controls extends more than a relatively short distance from the instrument and this should further aid robustness.

The COS5042TM offers a very good performance combined with a rugged construction, and small size. It does have one or two minor drawbacks, such as its lack of triggering sensitivity and B timebase facilities, but overall these do

Table 14

CATEGORY	Unsatisfactory	Satisfactory	Good	Very Good	Excellent
TRIGGER FACILITIES				*	
TRIGGER PERFORMANCE			*		
DEL'D SWEEP FACILITIES			*		
DEL'D SWEEP PERFORMANCE					*
CRT BRIGHTNESS				*	
CRT FOCUSING				*	
Y-AMP ATTENUATION RANGE				*	
INTERNAL CONSTRUCTION				*	
EXTERNAL CONSTRUCTION				*	
OVERALL SPECIFICATION					*
OVERALL PERFORMANCE				*	
EASE OF USE				*	
MANUAL				*	

not significantly affect the performance of the scope. It is likely to appeal to those users who require real portability coupled with the performance and features it offers. When compared with other scopes in its class, the 5042 comes out particularly well on Y-amp performance and power consumption, which will obviously be of more importance to some users than others.

The review model of the Kikusui COS5042TM was available for a very short time only, and it was, therefore, not possible to carry out the review in depth in respect of the more minor points.

The Kikusui COS5042TM was supplied by Telonic Instruments Ltd, Boyn Valley Road, Maidenhead, Berkshire SL6 4EG. Tel: (0268) 73933

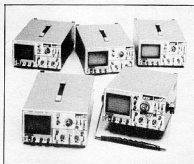

Fig. 20. Some other oscilloscopes in the Kikusui range.

Other scopes available under £1500 in the Kikusui range.

COS 5020TM-2.2 kV CRT; 1 mV maximum sensitivity; DC-20 MHz bandwidth; alternate channel triggering+level lock; single timebase (max sweep 20 ns/div); £360+VAT

COS 5021TM-same as 5020+delayed sweep (2 μ s to 5 ms)-£490+VAT

COS 5040TM-12 kV CRT; 1 mV maximum sensitivity; DC-40 MHz bandwidth; alternate channel triggering+level lock; single timebase (max sweep 20 ns/div)-£565+VAT

COS 5041TM-same as 5040+delayed sweep (2 μ s to 5 ms)-£625

COS5042TM-covered in review-£715

COS 5060TM-same as 5042, but 60 MHz bandwidth (a large number of these have been bought by British Telecom.)-£820+VAT

COS 5100TM-Same as 5042 except for 100 MHz bandwidth; 18 kV CRT, max sweep 2 ns/div-£1145+VAT

COS 6100A-similar to COS 1500TM, but different design + 12 trace capability; 20 kV CRT-£1450

Grundig MO22

Grundig's MO22 oscilloscope is based on the MO20 (reviewed in our January 1988 issue), but it has, for instance, a second timebase and fully automatic control of the main timebase. Because of this, the triggering facilities and Y amplifiers will be discussed in detail again, as they are virtually identical to those found in the MO20. The MO22 retails at £499, excluding VAT.

The MO22 is, like the MO20, fitted with a non-removable mains lead which is terminated in a standard 2 pin IEC type plug. Layout is similar to the MO20, although, as can be seen from the photograph, the whole of the top half of the scope is taken up by the timebase and triggering controls, which include automatic timebase selection. The Y amplifier controls are mounted on the lower half. All controls are very easy to operate and clearly marked. Both the B timebase and Y amplifier range selection switches have no endstops, which can be inconvenient if the scope needs to be switched quickly to one of its end ranges.

Automatic triggering is provided on the MO22, along with high and low frequency coupling. The B timebase is also triggerable, although the triggering threshold is set by the single trigger level control, meaning that both timebase are triggered on the same threshold. In the vast majority of situations this should not be a significant limitation, and pays dividends since it ensures both traces are stable. The B trigger modes are continuous delay and triggered delay, in which mode the second timebase can either be triggered on the rising or falling slope of a waveform.

Triggering of the second timebase is effective across the whole bandwidth and extends to approximately 70 MHz in both automatic (p-p) and normal triggering modes. This is, however, when

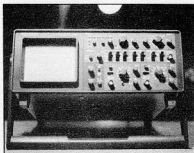

Fig. 21. The Grundig MO22 oscilloscope.

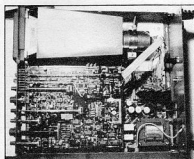

Fig. 22. Internal view of the MO22.

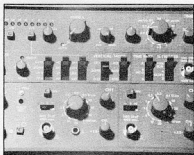

Fig. 23. Detail of the MO22 front panel.

using the soft tuning facility for manual selection of the A timebase sweep speed. When the A timebase was placed in automatic mode, a maximum reliable trigger frequency of 35 MHz was obtained, this being for the triggering of both the automatic facility and the timebase itself. A trigger holdoff facility is also provided, which is very effective in providing accurate triggering on a wide variety of waveforms. Its performance was particularly good on pulse and digital waveforms, providing a stable trace under almost any alteration of the frequency of the waveform and over a very wide range of timebase speeds (including automatic). External triggering is also good with a typical sensitivity of 400 mV and a maximum bandwidth approaching 40 MHz, allowing the external synchronization of most events.

Probably the main asset of the MO22 is its fully automatic main timebase, which enables very fast and easy operation of the scope when waveforms of a fairly constant amplitude, but not frequency, need to be measured. Timebase speeds range from 220 ms/div to 500 ns/div, or 50 ns/div if the $\times 10$ magnifier is brought into operation, this being covered in 18 steps, either by automatic or manual soft tuning via a continuously variable control. Timebase range indication is by 11 green LEDs. This takes into account the 9 'range' indicators, which are calibrated in the standard I-2-5 sequence, as well as two scaling LEDs, which indicate whether the range indicators are calibrated in micro or milli seconds. Auto mode is indicated by a single red LED, timebase speed still being given by the remaining indicators. When in soft tune mode, the continuously variable control gives a linear response; it is very easy to set the desired timebase speed. A large amount of hysteresis is provided between the range switching thresholds, preventing any

Table 16

CATEGORY	Unsatisfactory	Satisfactory	Good	Very Good	Excellent
TRIGGER FACILITIES				*	
TRIGGER PERFORMANCE				*	
DEL'D SWEEP FACILITIES			*		
DEL'D SWEEP PERFORMANCE			*		
CRT BRIGHTNESS				*	
CRT FOCUSING				*	
Y-AMP ATTENUATION RANGE					*
INTERNAL CONSTRUCTION				*	
EXTERNAL CONSTRUCTION					*
OVERALL SPECIFICATION					*
OVERALL PERFORMANCE				*	
EASE OF USE				*	
MANUAL			*		

Note: Delayed sweep performance and facilities compared to other scopes with 'coarse' delayed sweep. Also CRT brightness and focusing compared to other 20 kV tubes.

unstable timebase speeds over the control's full range. Overall, I found that this enables a very accurate, easy and convenient way of selecting the sweep speed, combining the speed of a conventional switched timebase speed control with the ease of use of a two-way 'up-down' rocker switch, which can be found in some other scopes with this facility. The LED display also gave a clearer, and in my view easier, to read display than the conventional switched system, although it is perhaps not as easy to read as would be a numeric 7 segment display, examples of which can be found on other digital timebase scopes. The automatic timebase facility itself is selected by placing the soft tuning control in a fully anticlockwise position. Operation of this was very effective, locking effectively onto a wide range of frequencies and producing a very stable display. The effective frequency range (4 cycles division) is 4 Hz to 800 kHz, although obviously the actual frequency range is what can be expected from a normal analogue timebase. Timebase switching occurs at between two and six cycles/10 divisions, depending on the range, and whether the timebase is being scaled up or down. Switching between the ranges is very fast on most sweep speeds, but it was noticeable that there was a small time delay when changing down in sweep speed. This is not, however, clearly noticeable until changing down from, for example, 200 μ s/div to 2 ms/div, when a delay of approximately 1 second is present. This increases to about 3 seconds when switching to 200 ms/div, the slowest sweep range. These are 'worst cases' and typically may be considerably faster, depending largely on the waveform and previous speed setting. Performance of the autoringing system was good, locking onto a large range of waveforms, from a sine wave to a complex pulse train.

Overall, I also found the automatic timebase an extremely useful facility with few failings, although as a very minor point it might have been helpful to have an automatic $\times 10$ deflection speed facility to increase the maximum speed under automatic control to 50 ns/div in place of the 500 ns/div for higher frequencies.

The second timebase/delayed sweep is of the 'coarse' type, in that in most circumstances it is not possible to carry out accurate timing measurements in situations where a calibrated delay time multiplier would normally be required. Waveform expansions can, however, be carried out accurately by the second timebase. For unstable, or changing, frequencies, it is obviously advisable to use the soft tuning option of the main timebase, although where this is not the case, the autorange option can be used with good results. The analogue second timebase sweep speeds range from 2 ms/div to 0.5 μ s/div, and can be used in one of two modes, either intensifying the trace to be magnified, or as the magnified sweep. It is worth noting that in common with most other 'coarse' delayed sweep systems only one timebase can be displayed at a time, i.e., either A or B, and not both, thus giving a maximum of two traces on the screen at any one time. Jitter is one part in 10,000, and as such is just visible on high magnification ratios, although it can be kept to a minimum in some situations by using the triggered delay facility. The delay time is variable by an uncalibrated control over 10 horizontal divisions, and as mentioned above can either be continuous or triggered.

CRT performance is obviously comparable to the MO20, since the same CRT and drive circuitry are used. Typical magnification ratios in normal (artificial lighting) conditions were 1000:1 without the $\times 10$ magnifier in operation, or, with

Table 15

ELECTRICAL CHARACTERISTICS

Line voltage: 100,220,240 VAC $\pm 10\%$; internally adjustable.
Line frequency: 45-65 Hz
Power consumption 35 Watts

MECHANICAL CONSTRUCTION

Dimensions: W 375 mm, H 160 mm, D 430 mm
Housing: steel sheet
Weight: approx. 8.5 kg

Y AMPLIFIER ETC.

Operating modes:
CH1 alone, CH2 alone
Inversion capability on CH1 or CH2
Dual CH1, CH2 (alternate or chopped (250 kHz))
CH1 + CH2

Frequency response: 0...20 MHz (-3 dB).
Risettime: ≤ 17.5 ns, (23.4 ns $\times 5$ Mag.)
Deflection factor: 12 steps:
5 mV/div...20 V/div $\pm 3\%$, vernier control adjusts max. sensitivity on 5 mV/div range to 2 mV/div (fully ccw)
Input coupling: AC, DC or Gnd.
Input impedance: 1 M Ω /25 pF
Max input voltage 400 (DC + peak AC)

X-Y MODE

CH1 X-axis and CH2 Y-axis. Less than 3° phase shift at 50 kHz
Bandwidth DC to 1 MHz (-3 dB).

SWEEP

Operating Modes: A; timebase A only; A intens. B; A brightened in range B, remainder blanked; B; timebase B only
A Sweep Time: 0.5 μ s/div to 0.2 s/div, $\pm 3\%$ in 18 ranges, 1-2-5 sequence. Vernier control slows sweep down by up to 2.5:1;
B sweep: 0.5 μ s/div to 20 ms/div, $\pm 3\%$ in 12 ranges, 1-2-5 sequence.
Range Selection: A-automatic or manual (potentiometer); B-switched
Sweep magnification: $\times 10 \pm 5\%$ total error
Holdoff: variable up to 10:1
Delay modes: Trigger Delay (slope switchable); Continuous delay
Delay jitter: 1/10000

TRIGGERING

Trigger modes: Auto (p-p), Normal
Trigger coupling: AC, DC, HF reject, LF reject, TV frame and line(auto).
Trigger sources: CH1, CH2, Line, Ext.
Triggering sensitivity: Internal ≤ 1 div at 20 MHz, External ≤ 0.5 V p-p at 20 MHz, Normal mode

MISCELLANEOUS

CRT-make: Valvo, measuring area 80 mm \times 100 mm, accelerating voltage 2 kV
Compensation signal for divider probe; amplitude approx. 1 Vpp ($\pm 3\%$), frequency 1 kHz
Z modulation Sensitivity: 3 V (complete blanking)
Covered by 1 year warranty.

this, approximately 100:1. For a 2 kV tube these figures are certainly above average, especially as the traces at these speeds were fairly well defined. Z modulation is provided as standard on the MO22 and exhibited a very good sen-

sitivity of +2 V for total blanking of a trace at maximum brightness. Negative voltages have no effect however, so the trace cannot be intensified by an external voltage.

Internal construction, like that of the MO20, is based on two PCBs; the lower one, housing the Y-amplifiers, power supply, etc., is almost identical to that used in the MO20. The upper board is entirely different, however, and houses all the components for both timebases, as well as the trigger circuitry. Both PCBs are of fibre glass construction and screened with both component identification numbers, and, where appropriate, their functions. The PCBs are held in place by a steel chassis which should be extremely rugged under a very wide range of operating and environmental conditions. The outer casing is also steel; the absence of ventilation slots makes the MO22 externally resilient to a range of conditions compatible with those outlined above.

The manual is very similar to that supplied with the MO20, the main differ-

ence being a very brief explanation of delayed sweep operation

CONCLUSION

The Grundig MO22 represents a considerable advance in terms of timebase technology for an oscilloscope in its price range. I found the automatic timebase facility genuinely useful, making the measurement of a wide range of waveforms significantly easier and faster. The second timebase provides a good range of sweep speeds and thus expansion ratios, although its use in delayed sweep applications is limited in some situations by the lack of a calibrated sweep delay and delay line for triggered operation, and, of course, the 2 kV CRT. These features, however, cannot really be expected in this price range, especially when the high grade of construction and additional features are taken into consideration. This, along with the automatic timebase, should make the scope ideal for service work, particularly in the TV area as the TV triggering was very effective in both

horizontal and vertical modes. To sum up the Grundig MO22 is unique in its price range in having in fully automatic timebase. The advantage of this over a conventional analogue system obviously depends on the application, but from my own experiences I have found it well worth while. This, coupled with the second timebase, should make the scope a good choice where ease of use and versatility are among the main requirements, such as in a servicing or educational environment.

The Grundig MO22 was supplied by Electronic Brokers Ltd., 140-146 Camden Street, London, NW1 3YP. Tel: 01-267 7070

Other scopes available under £1500 in the Grundig range.

MO53

Dual trace 50 MHz bandwidth. Full autoranging timebase with digital readout; trigger holdoff; TV line and field (1 or 2) triggering; 11 kV CRT; calibrated delayed sweep facility.

LOW-NOISE PREAMPLIFIER FOR FM RECEIVERS

First in a short series of articles on simple to build RF preamplifiers is a tuneable aerial booster for the FM band.

The RF preamplifier described here is intended for fitting as close as possible to the FM band aerial. It is a tuneable, rather than a wideband, amplifier, which is fed and tuned via the downlead coax cable. The amplification and the noise figure of the FM aerial booster are 25 dB and about 1 dB, respectively. All preamplifiers described in this series are powered and tuned by a common supply/tuning unit installed at an appropriate location in the home.

Circuit description

The circuit diagram of Fig. 1 shows that the preamplifier is a conventional design based on a VHF MOSFET tetrode Type BF981. The preamplifier input can be connected to unbalanced (60...75 Ω) as well as balanced (240...300 Ω) aerials or feeder systems. The balanced input

allows the preamplifier to be connected direct to the dipole element. In this case, the preamplifier can take the place of the balun removed from the ABS, water-resistant, enclosure that houses the dipole terminals. This solution ensures the lowest possible input loss, and obviates the need for a separate preamplifier enclosure on the mast.

The balanced or unbalanced aerial signal is applied to winding a of tuneable inductor L_1 . Varactors D₁-D₂ form the adjustable capacitance across winding b, so that the tuning range of L_1 is about 86...109 MHz. Gate 2 of DG MOSFET T₁ is held at about +4 V by potential divider R₂-R₃. The bias voltage is effectively decoupled by surface mount capacitor C₁. Blocking capacitor C₂ takes the amplified RF signal from a half-impedance tap on drain inductor L₂.

The MOSFET is fed with a constant operating voltage of 12 V, supplied by

regulator IC₁. The direct voltage on the downlead coax can be varied between 15 V and about 26 V by means of the supply/tuning unit near the receiver. Zener diode D₃ in the preamplifier ensures that the tuning voltage for varactors D₁-D₂ is the voltage on the downlead coax minus 12 V. Example: if the downlead coax carries +18 V, the tuning voltage at junction D₁-D₂ is +6 V with respect to ground. The lowest downlead voltage is about 15 V to ensure the minimum voltage drop across regulator IC₁. Choke L₃ forms a high impedance for the amplified RF signals superimposed on the tuning/supply voltage.

Construction

Commence the construction of the preamplifier with winding the inductors.

Input inductor L_1 is wound on the former in the Type 10V1 inductor assembly from Neosid—see Fig. 2. First, close-wind L_{1a} as 11 turns, $\varnothing 0.6$ mm enamelled copper wire. Study the component overlay on the PCB (see Fig. 3) to find the 2 pins on the base that connect to L_{1a} . Close-wind L_{1b} as 4 turns, $\varnothing 0.6$ mm enamelled copper wire onto L_{1a} , starting at the base of the plastic former. The tap is made after 2 windings. Stretch the turns, and carefully scratch off a small area of the enamel coating approximately half-way the inductor. Solder a short wire to this point, and point it down towards the base. Press the inductor together again. Connect the end wires and the tap wire to the base pins, and verify continuity and orientation of the completed inductor. Drain inductor L_2 is wound as 4 turns $\varnothing 0.3$ mm enamelled copper wire through a small ferrite bead. The centre tap is made after two turns by twisting

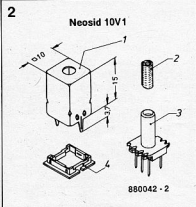

Fig. 2. The Type 10V1 inductor assembly from Neosid.

3 cm or so of the wire before making the third and fourth turn. The twisted wire is then cut to length, the enamel coating is scratched off, and the connection is carefully pre-tinned.

Choke L_3 is the simplest to make: it is wound as 6 turns $\varnothing 0.2$ mm enamelled copper wire through a small ferrite bead. The three home-made inductors in the preamplifier are shown in the photograph of Fig. 4.

The PCB for this project is a double-sided, but not through-plated, pre-tinned type. The four resistors are mounted upright. Ascertain the pinning of MOSFET T_1 before fitting it on the printed circuit board: depending on the make of the device, it may be necessary to mount it with the type indication facing the PCB.

The ground terminal of R_2 , R_4 , IC_1 , C_2 , C_3 , C_4 , C_5 , the source terminal of T_1 , the anode of D_2 , input pin 2, the 2 solder tabs on the shielding can of L_1 , and the output ground terminal, are

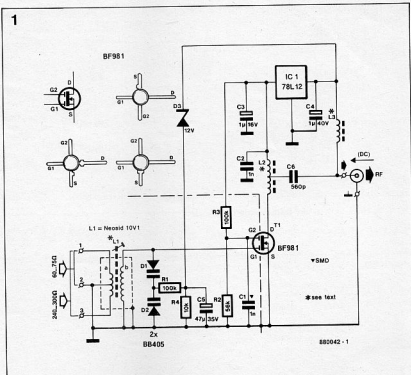

Fig. 1. Circuit diagram of the tuneable VHF preamplifier.

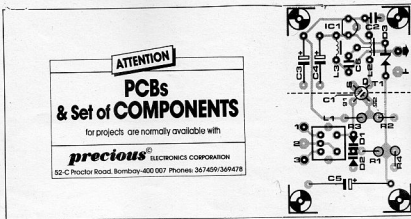

Fig. 3. The PCB for building the VHF preamplifier.

soldered at both sides of the PCB. The only component at the track side of the board is SMD capacitor C_1 . This is soldered direct across the GATE 2 and SOURCE connections of the MOSFET. Fit a 15 mm high brass or tin metal screen with a small clearance for the MOSFET as shown on the component overlay.

Supply/tuning unit

The circuit diagram of the simple, regulated and adjustable, power supply for the download-powered preamplifiers is shown in Fig. 6. The output voltage of

integrated regulator IC_1 is adjusted between 15 V and 26 V with tuning control P_1 . The tuning and supply voltage for each preamplifier is applied to the centre core of the respective download coax cable by a choke-resistor combination. The tuning/supply unit is built on the double-sided, pre-tinned printed circuit board shown in Fig. 7. Construction should not present problems: grounded component leads or terminals are soldered at both sides of the PCB. Fit IC_1 with a TO220-style heat-sink, but make sure that this is insulated from the ground area.

4

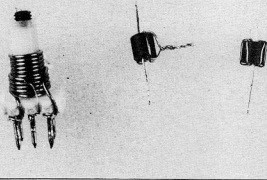

Fig. 4. A close look at the home-made inductors.

Parts list

FM BAND PREAMPLIFIER, CIRCUIT DIAGRAM:
FIG. 1.

Resistors ($\pm 5\%$):

R₁; R₃ = 100K
R₂ = 56K
R₄ = 10K

Capacitors:

C₁ = 1n0 (surface mount assembly)
C₂ = 1n0 ceramic (pitch: 5 mm)
C₃ = 1 μ 0; 16 V; axial
C₄ = 1 μ 0; 40 V; axial
C₅ = 47 μ ; 35 V; axial
C₆ = 560p ceramic (pitch: 5 mm)

Semiconductors:

D₁; D₂ = BB405

D₃ = zenerdiode 12 V; 400 mW
IC₁ = 78L12
T₁ = BF981

Inductors:

Winding data are given in the text.

L₁ = inductor assembly Type 10V1. Neosid part number: 15955100. (Neosid • Eduard House • Brownfields • Welwyn Garden City • Herts AL7 1 AN. Telephone: (0707) 325011. Telex: 25423).
2 off small, single-hole, ferrite beads (length: approx. 3 mm).

Miscellaneous:

Suitable waterproof enclosure.
PC3 Type 890042 (see Readers Services page).
5 off soldering pins.

The winding data for the 3 chokes on the board are as follows:

L₁; L₂; L₃ = 6 turns $\varnothing 0.2$ mm enamelled copper wire through a small ferrite bead (length: approx. 3 mm).

The tuning control, P₁, is conveniently fitted onto the 3 soldering pins to go round a 3-wire connection. The assembled board, the 24 VAC power transformer, mains switch and fuse are housed in a small enclosure with a sloping front panel. Omit D₁...D₂ incl., and C₁-C₂, when a 24 VDC source, such as a mains adapter, is already available—connect this to the points marked + and 0. The tuning control can be fitted with a vernier and a scale for the frequency range of each preamplifier.

Testing

Connect the AC input of the completed tuning/supply unit to the secondary of the 24 VAC mains transformer, apply power, and verify the presence of the adjustable direct voltage on the three DC/RF terminals. Check whether P₁ sets the voltage between +15 V and +26 V.

5

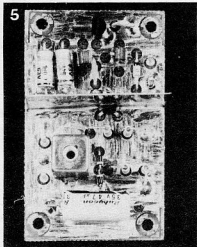

Fig. 5. Prototype of the completed low-noise preamplifier.

6

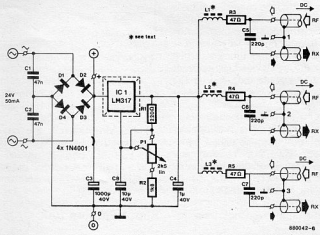

Fig. 6. Circuit diagram of the tuning/supply unit.

ATTENTION

PCBs & Set of COMPONENTS

for projects are normally available with

precious® ELECTRONICS CORPORATION

52-C Proctor Road, Bombay-400 007 Phones: 367459/369478

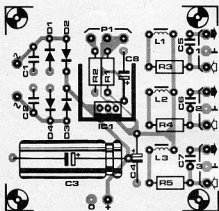

Parts list

TUNING/SUPPLY UNIT. CIRCUIT DIAGRAM:
FIG. 6.

Resistors ($\pm 5\%$):

R1 = 220R
R2 = 1K8
R3, R4, R5 = 47R
P1 = 2K5 or 2K2 linear potentiometer

Capacitors:

C1, C2 = 47n
C3 = 1000 μ ; 40 V
C4 = 1 μ ; 40 V
C5, C6, C7 = 220p
C8 = 10 μ ; 40 V

Inductors:

L1, L2, L3 = home made on 3 mm ferrite
beads - see text.

Semiconductors:

D1... D4 incl. = 1N4001
IC1 = LM317 (TO220 enclosure)

Miscellaneous:

TO220-style Heat-sink for IC1.
11 off soldering pins.
PCB Type 8B0041 |

Fig. 7. The printed circuit board for the tuning/supply unit.

Tune the FM receiver to a relatively weak transmission at about 108 MHz, and make a note of the signal strength. Connect the input of the completed preamplifier to the aerial, **not** a cable network outlet. The preamplifier output is connected to the appropriate soldering terminal on the tuning/supply board via a short length of coax cable. Similarly, connect the unbalanced (75 Ω) input of the FM receiver to the RF (RX) output on the tuning/supply board. Set P1 to +26 V on the cable to the preamplifier. Verify the presence there of +12 V on C3, and +14 V on C5. Use a plastic trim tool to adjust the screw core in L1 for optimum reception. Vary the supply

voltage between 22 V and 26 V to check that this tunes the preamplifier.

Set the supply to +15 V, and tune the receiver to a signal at the lower band edge, i.e., approximately 88 MHz. Check that L1 is still adjusted for optimum reception by carefully adjusting the core. Tune to a number of stations at regular frequency intervals in the FM band, optimize reception by adjusting P1 in the tuning/supply unit, and make notes of the download voltage. If necessary, redo the adjustment of L1 to ensure that the span of the tuning voltage covers the entire FM band. For optimum tracking of

the resonance frequency with the tuning voltage applied to the varactors, the core in L1 should be turned to about half-way the aerial winding. This completes the initial adjustment of the FM band preamplifier, which is ready for fitting into a waterproof enclosure.

The next instalment in this series will deal with preamplifiers for the short-wave, VHF and UHF TV bands. **B**

spot sinewave generator

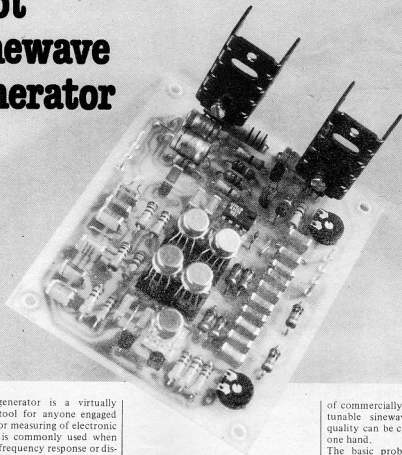

A sinewave generator is a virtually indispensable tool for anyone engaged in the testing or measuring of electronic equipment. It is commonly used when measuring the frequency response or distortion characteristics of audio equipment. In particular, harmonic distortion is still considered to be one of the important parameters in performance of audio amplifiers, and in order to measure this accurately, it is obviously imperative that the input test signal itself have as little distortion as possible. In fact the distortion of the input sinewave must be at least an order lower than that introduced by the amplifier. Furthermore, it is important that the frequency of the sinewave be extremely stable, if one is to avoid having to constantly retune the notch filter in the distortion meter (see the circuit for a distortion meter published in *Elektron* 27/28, July/August 1977). The amplitude stability of the sinewave is of secondary importance in distortion measurements, however it is often a critical factor in a number of other test applications.

Continuous or 'spot'

If all three of the above-mentioned demands on a sinewave generator, viz. amplitude stability, constant frequency, and extremely low distortion, are to be satisfied, then unfortunately it more or less precludes the use of a sinewave generator with continuously adjustable frequency. It is true that such devices do exist, however they are exceedingly complex and expensive, and the number

There are a number of measurement jobs which require an AC test signal, which, as nearly as possible, is a perfect sinewave. Not only must the amplitude of the signal be absolutely stable, but the hum, noise and harmonic distortion components must be reduced to a minimum. The spot frequency sinewave generator described here will provide a sinewave output with harmonic distortion of less than 0.0025% and whose amplitude is constant to within 0.1%.

of commercially available, continuously tunable sinewave generators of high quality can be counted on the fingers of one hand.

The basic problem with continuously adjustable sinewave generators is amplitude instability. In almost every case, the sinewave output is produced by an oscillator circuit. (1) An oscillator is essentially an amplifier with positive feedback, whereby the feedback loop contains suitable frequency-selective networks of capacitors and resistors. In the example of the Wien bridge oscillator shown in figure 1, positive feedback is applied via the RC network to the non-inverting input of the op-amp, whilst negative feedback is applied to the inverting input via the voltage divider network formed by R_0 and the negative temperature coefficient resistor (thermistor).

If the negative feedback exceeds the positive feedback the oscillations will not be sustained and the output of the amplifier will fall; if the positive feedback predominates, however, the output of the amplifier will rise until the latter

footnote 1

In order to clear up any misunderstandings: a sinewave generator need not contain an oscillator. A sinewave signal can be obtained by, e.g. suitable filtering of a squarewave provided by an external oscillator circuit. As we shall see, however, if the squarewave is derived from the sinusoidal output of the generator, then the latter must of course contain an oscillator.

Specifications

Harmonic distortion: < 0.005%

for: $f = 40 \text{ Hz} \dots 10 \text{ kHz}$

$U_{\text{out}} < 6 \text{ V}_{\text{pp}}$

$R_L > 600 \Omega$ (output I)

$R_L > 47 \Omega$ (output II)

typically: 0.0025% falling linearly with amplitude

Frequency stability: $\frac{\Delta f_{\text{osc}}}{f_{\text{osc}}} < 0.01\%$

Amplitude stability: $\frac{\Delta A}{A} < 0.1\%$

1

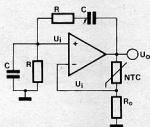

9948-1

$$\left(\frac{U_i}{U_o}\right)_{f_0} = k = \frac{1}{3}$$

$$R_{\text{NTC}} = R_0 \frac{1-k}{k} \approx 2R_0$$

$$f_0 = \frac{1}{2\pi RC}$$

Figure 1. The basic principle of a Wien bridge oscillator.

Figure 2. Basic block diagram of the oscillator employed in the spot sinewave generator.

Figure 3. The amplitude- (a) and phase response (b) of the type of selective bandpass filter used in the spot sinewave generator. Curves '1' show the response obtained for a low Q, curves '2' for a high Q. The combined response of two such filters connected in cascade can be obtained by adding the individual amplitude/phase curves of each filter.

2

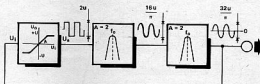

9948-2

saturates. The circuit is prevented from lapsing into either of these two conditions by the thermistor, which stabilises the output amplitude as follows: should the output voltage rise, the current through the thermistor will increase, causing its temperature to rise and hence its resistance to fall. This causes an increase in the proportion of negative feedback, thereby automatically reducing the gain of the op-amp. The opposite occurs when the output voltage tends to fall; the resistance of the thermistor is reduced since it dissipates less heat, thus also reducing the amount of negative feedback.

Assuming that the resistor and capacitor values in the two arms of the bridge are identical, the proportion of output voltage which is fed back round the positive feedback loop at the resonant frequency, f_0 , of the oscillator is $1/3$. The output voltage of the oscillator settles at the value which ensures that the resistance of the NTC resistor is equal to $2R_0$. It is obvious that the frequency of the oscillator could be continuously adjusted by using a stereo potentiometer or twin-ganged trimmer capacitor to vary the RC time constants in the arms of the bridge. However, in practice it is impossible to obtain stereo pots or trimmers in which both gangs are perfectly matched. Variations in the resistance or capacitance values between the two arms of the bridge have the effect of altering the positive feedback factor, k , the result of which is a change in the resistance value of the thermistor

3a

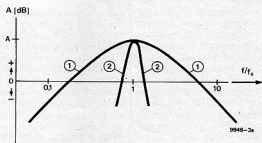

9948-3a

3b

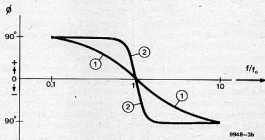

9948-3b

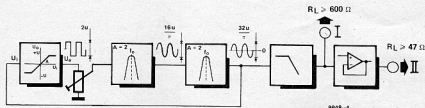

Figure 4. Complete block diagram of the spot sinewave generator.

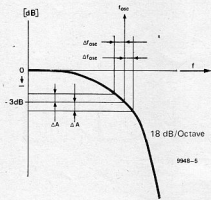

Figure 5. The effect of changes in frequency and of the slope of the lowpass output filter upon the amplitude stability of the generator.

Figure 6. Complete circuit diagram of the spot sinewave generator.

(see figure 1). Thus varying the frequency of the oscillator has the effect of also varying the amplitude of the output signal. What is more, the amplitude of the output signal at the new frequency (after the balance between positive- and negative feedback has been re-established) differs from that obtained before the change in frequency.

The op-amp is not the only source of distortion in the sinewave output (this can be counteracted by a high open-loop gain); a further contributory factor is the fact that the voltage-current transfer characteristic of the thermistor is not completely linear. Other amplitude-stabilising components such as filament lamps, diode-resistor networks or voltage-controlled FETs can be used, but these are also by no means perfect.

For a large number of applications the above-mentioned failings are not particularly critical; however, for measurement purposes where accuracy is important, they represent an unacceptable source of error. For this reason, the most common solution is to do without the admittedly attractive facility of continuously adjustable frequency and to settle instead for an oscillator with a number of switched output frequencies. Basically this amounts to a series of individual oscillators each designed to produce a single optimal frequency. This elegantly solves the problem of amplitude stability which bedevils continuously variable oscillators. If one considers that a high-quality continuously variable sinewave generator will

cost in the region of £ 500 - £ 600, whilst a (simple) spot frequency sinewave oscillator on the other hand can be constructed for under £ 10, and furthermore, that only four or five test frequencies are normally required in harmonic distortion measurements, then it is clear that a spot frequency generator represents a highly cost-effective approach. The distortion meter published in the Summer Circuits 1977 is also designed for spot frequency measurements.

Spot sinewave generator

The basic principle of the spot sinewave generator described here should be familiar to a number of readers, since it was used in the design for a simple spot sinewave generator published in last year's Summer Circuits issue (circuit 25). The operation of the circuit is illustrated by the block diagram shown in figure 2. A symmetrical squarewave signal is fed to a number of cascaded selective filters (in figure 2 two such filters are used). These remove the harmonic content of the squarewave, leaving the more or less pure sinusoidal fundamental. The resulting sinewave is in turn used to trigger the squarewave from which it is derived. The amplitude of the sinewave is clipped to $\pm u$, before being fed back to the input of the squarewave oscillator, so that the oscillations are maintained. For this in fact to happen, two conditions must be fulfilled: the input- and output signals

must be in phase; this means that the phase shift of the selective filters must be either 0° , 360° or a multiple of 360° (the phase shift introduced by the clipping circuit can be neglected). Secondly, the loop gain of the system at the oscillator frequency, f_{osc} , must be greater than 1. The former is the product of the gain of the clipping circuit plus that of the selective filters, and any damping introduced by an attenuator which may be included in the system. In figure 2 the centre frequencies of the two selective filters are identical, hence $f_{osc} = f_0$.

The output signal of the clipping circuit is not a perfect squarewave, since it does not have an infinite gain. Strictly speaking the output is a clipped sinewave, which has more in common with a symmetrical trapezoidal waveform. This is all to the good, however, since this type of waveform has fewer harmonics to filter out than a perfect squarewave. Figure 3a shows the amplitude response curve of the type of selective filter employed in the circuit, whilst in figure 3b we see the phase response of the filter. The overall response of a number of filters connected in cascade can be obtained by adding each point of the separate response curves for each filter. The resonant frequency of the system is that at which the combined phase response curve intersects the x-axis. With two selective filters whose centre frequencies, f_{01} and f_{02} , are offset slightly, the resonant frequency f_{osc} will equal $\sqrt{f_{01} \cdot f_{02}}$. The amplitude

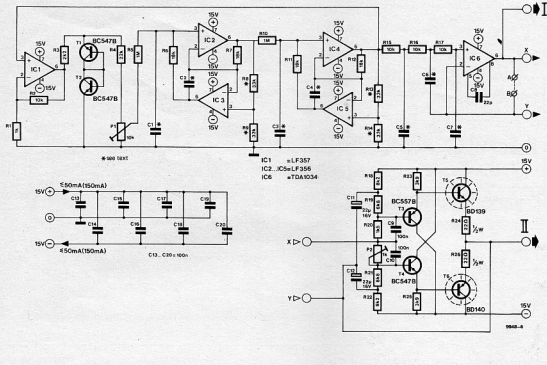

values shown in figure 2 assume that the output signal of the limiter is a perfect squarewave and that the resonant gain of each filter is 2. The harmonic suppression of the filters is discussed in Appendix 2 at the end of the article.

Practical design

The block diagram of the full spot sine wave generator is shown in figure 4, whilst figure 6 contains the complete circuit diagram. In contrast to figure 2, the block diagram of figure 4 contains a variable attenuator (in the shape of a potentiometer), a lowpass filter and an output buffer stage.

In addition to varying the amplitude of the output signal, the potentiometer fulfils a second function. Without some kind of signal level control at this stage there is the danger that an excessively large input signal would overload the filters, causing their output to clip.

The output buffer stage ensures that, even under heavy load conditions, the generator can provide a low distortion output signal. It is an obvious step to combine the output buffer with an 18 dB per octave lowpass filter — all that is needed is three extra resistors and capacitors. If the turnover frequency of the filter is calculated to roughly coincide with the oscillator frequency, the result is further suppression of harmonics without incurring too great a voltage loss or significantly affecting the amplitude stability of the output signal. This latter point may

require further explanation: see figure 5. If one assumes that the oscillator frequency can vary by a factor of $\pm \Delta f_{osc}$ (the frequency stability is then

$$\frac{\Delta f_{osc}}{f_{osc}} \times 100\%), \text{ then the amplitude of}$$

the output signal of the lowpass filter can vary by $\pm \Delta A$; the result is that in addition to variations in amplitude caused by the oscillator itself, the amplitude of the sine wave generator output can be affected by variations in the output of the lowpass filter caused by frequency drift. Fortunately, in view of the extreme stability of the oscillator and the relatively gradual roll-off in the lowpass filter's response at the 3 dB point, this effect is of little practical importance. The detailed circuit diagram of the spot sine wave generator is shown in figure 6.

The clipping circuit is built round IC1, (which has a gain of 11) R3, and T1 and T2, which are connected as symmetrical zener diodes. The trapezoidal voltage at the junction of R3 and R4 is attenuated by R4 and P1, and fed to the first selective filter consisting of IC2, IC3, R5... R9, C1 and C2. The second bandpass filter (IC4, IC5, R10... R14, C3, C4) is identical to the first; a more detailed discussion of these filters is contained in Appendix 1 at the end of the article.

The frequency-determining components of the lowpass filter are R15, R16, R17, C5, C6 and C7, whilst IC6 is the associated emitter follower, which also

functions as output buffer. If desired, a symmetrical emitter follower (T3...T6 etc.) can be connected to the output of IC6, allowing the generator to be used with load impedances as low as 47 Ω . If load impedances as low as this are not foreseen, the emitter follower components can be omitted, points A and B are linked together and outputs I and II can be used with impedances of 600 Ω or greater.

The frequency of the oscillator is determined by the choice of component values for C1...C7:

$$C1 = C2 = C3 = C4 = \frac{8.842}{f_{osc}}$$

$$C5 = \frac{22}{f_{osc}}; \quad C6 = \frac{56}{f_{osc}}; \quad C7 = \frac{3.9}{f_{osc}}$$

Capacitances are in nanofarads, the oscillator frequency is in kHz.

Construction

Figures 7 and 8 show the copper track pattern and component overlay respectively of the p.c.b. for the 47 Ω version of the spot sine wave generator. Figure 9 shows the component layout for the version without the emitter follower output buffer (into 600 Ω or above).

As far as the choice of component values are concerned, the values given for R8, R9, R13 and R14 are nominally 33 k; possible alterations to these values are discussed in the following section describing the calibration procedure. The values of R6, R7, R11 and R12

ATTENTION

PCBs & Set of COMPONENTS

for projects are normally available with

precious®
ELECTRONICS CORPORATION

52-C Proctor Road, Bombay-400 007 Phones: 367459/369478

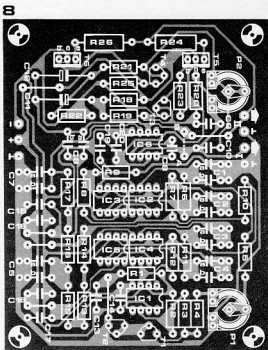

should be as closely matched as possible. The best procedure is to measure their resistance, but in practice it is sufficient to take four successive resistors from the 'belt' in which they are packaged. Although desirable, 1 or 2% metal-oxide types are not absolutely necessary. The values of C1...C7 are calculated from the equations listed above. Room has been provided on the p.c.b. to make up the correct values by connecting two capacitors in parallel. C1...C4 should also be as closely matched as is possible. If there are discrepancies in the values of C1...C4 or R6, R7, R11 and R12, it may slightly affect the quality of the output signal. However this can be rectified during the calibration procedure, which is described next.

Calibration

An oscilloscope is a prerequisite for correct calibration of the sinewave generator. After the usual checks the generator is connected to the oscilloscope and the power switched on. The wiper of P1 should be turned fully towards R4, whereupon, hopefully, a sinewave signal should appear on the screen. If, however, nothing happens, then the circuit is failing to oscillate, a state of affairs which is almost certainly due to the fact that the centre frequencies of the two selective filters are too far apart, with the result that the loop gain at the resonant frequency is less than 1. The first thing to do, therefore is tune in the frequencies of these filters. Figure 10a shows the

response curves of a number of selective filters of differing centre frequency whilst figure 10b shows three different response curves obtained: (1) when two filters with the response of curve 1 in figure 10a are connected in cascade (i.e. both filters have the same centre frequency); (2) when the centre frequencies of the two filters are slightly offset, as is the case with curves 2 in figure 10a; (3) and when the centre frequencies of the two filters are fairly far apart (curves 3 in figure 10a). The Q and resonant gain, A, of all the filters in figure 10a are identical. It is apparent that the greater the difference in the centre frequencies of the two filters, the smaller the gain at the resonant frequency (it may even fall to the point where the loop gain of the system is less than 1; see also Appendix 3), and also the less filtering of higher frequencies there is - i.e. less suppression of the higher harmonics.

One should thus attempt to ensure that the centre frequencies of the two bandpass filters are as close as possible, at least enough to ensure that the oscillator starts.

If, during the calibration procedure, the oscillator should initially refuse to start, the loop gain of the system should be temporarily increased by bridging R1 with a resistor of a couple of hundred Ohms. As soon as the oscillator starts, the output signals of both bandpass filters should be displayed on the scope.

The signals at pin 6 of IC2 and IC4 will almost certainly exhibit a considerable phase shift (if there was only a small shift the oscillator would have started

first time). The extent of the phase shift is a measure of the difference between the centre frequencies of the selective filters. Thus the centre frequency of one or both filters should be adjusted until the two signals are as nearly as possible in phase; at the same time the amplitude of the sinewave at the output of IC4 should rise. The adjustments are realised by altering the value of one or more of resistors R8, R9, R13 and R14 (see Appendix 1). Each resistor can be varied between 22 k and 68 k. Of course it is also possible to vary the value of other frequency-determining components (again see Appendix 1). Once the frequencies of the selective filters have been aligned as accurately as is possible, the resistance bridge across R1 can be removed. As described above, the more accurate tuning of the two filters will have the effect of increasing the resonant gain of the system; if as a result of this the output of one or both filters should start clipping, P1 should be adjusted until the loop gain is at a satisfactory level. The calibration procedure is then complete.

In conclusion

The spot sinewave generator requires a symmetrical stabilised supply of ± 15 V. The current consumption per oscillator is a maximum of 50 mA for the 600 Ω version and 150 mA for the 47 Ω version. The quiescent current of the output stage of the latter should be set to 100 mA using P2. The lower the amplitude of the output signal, the less harmonic distortion. Thus the size of

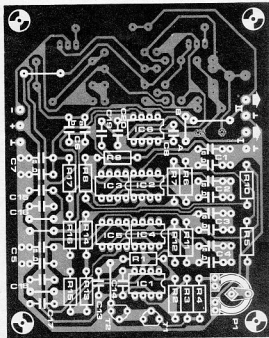

the output signal can be adjusted as desired by means of P1. There are two conditions attached to using P1 as an amplitude control however: it should be set neither too high as to allow clipping to occur, nor too low as to cause the oscillator to stop. It is also possible to omit P1 altogether. R4 and R5 are then joined and between this junction and earth a resistance of suitable value is inserted. In nine out of ten cases the value of a simple carbon resistor will prove stabler than that obtained using a potentiometer; the above step can therefore only improve the overall amplitude stability of the generator.

If several oscillator frequencies are required, then, in order to keep the component count down it would be logical to use a 9-pole switch (for C1...C7 and P1) with however many ways as one requires different frequencies. Although this represents the most elegant solution, whether it is the cheapest is another question.

Spot sinewave generators are of course most commonly used in AF applications, however the model described here can also be used for high frequency work. It was with an eye to this type of application that the 50 Ω output was provided. Unless one possesses a tunable two-tone generator, measuring the intermodulation distortion of r.f. amplifiers can be a difficult business. The two-tone generator produces a pair of signals of identical amplitude but differing frequency. If one feeds the output of the spot sinewave generator to a double-balanced mixer (DBM) (see figure 11) one obtains two output signals whose

frequencies differ by twice the frequency of the original input signal. Of particular interest are the uneven harmonic distortion components, since their frequencies lie in the region of the desired signals. The IM distortion of the two-tone generator itself must be less than -60 dB for reliable measurement purposes - a specification which the spot sinewave generator easily improves upon.

Bibliography:

1. Spot frequency sinewave generator; *Elektron* 27/28, July/August 1977.
2. Klein and Zaalberg van Zelst, A non-linear low output impedance AF oscillator with extremely low distortion, *Philips Technical Journal*, 25.20.1963.

Appendix

1. It can be shown that the centre frequency f_0 , the resonant gain, A, and the Q of the selective filter formed by IC2 and IC3 in figure 2 can be determined as follows:

$$f_0 = \frac{1}{2\pi\sqrt{\frac{R_8}{R_9} \cdot R_6 \cdot R_7 \cdot C_1 \cdot C_2}}$$

Figures 7 and 8. Track pattern and component layout of the p.c.b. for the circuit of figure 6. (EPS 9948).

Figure 9. Component layout for the version without the 47 Ω output.

Parts list:

Resistors:

R1 = 1 k
 R2, R15, R16, R17 = 10 k
 R3 = 2k2
 R4 = 22 k
 R5, R10 = 1 M
 R6, R7, R11, R12 = 18 k
 R8¹, R9¹, R13¹, R14¹ = 33 k
 R18¹, R22¹ = 8k2
 R19², R21² = 6k8
 R20² = 1k5
 R23², R25² = 3k9
 R24², R26² = 22 Ω/½ W
 P1 = 10 k preset
 P2 = 1 k preset

Capacitors:

C1, C2, C3, C4, C5, C6,
 C7 = see text³
 C8 = 22 p
 C9¹, C10¹, C13, C14, C15, C16, C17,
 C18, C19, C20 = 100 n
 C11², C12² = 22 μ/16 V

Semiconductors:

T1, T2, T4² = BC 107B, BC 547B
 or equivalent
 T3¹ = BC 177B, BC 557B or
 equivalent
 T5¹ = BD 139
 T6¹ = BD 140
 IC1 = LF 357 (National Semi-
 conductors or second sourced)
 IC2, IC3, IC4, IC5, IC6 = LF 356
 (National Semiconductors or
 second sourced)
 IC7 = TDA 1034 (Philips),
 NE 5534 (Signetics).

Notes:

1. nominal value, see text.
2. these components are only used for the 50 Ω version (output II, wire link AB is omitted)
3. Capacitors C1...C7 are formed by connecting two separate capacitors, a and b, in parallel to obtain the desired values.

N.B. The component overlay shown in figure 9 is only valid for the standard (600 Ω) version of the circuit; the overlay shown in figure 8 is correct for both the standard and extended (50 Ω) versions. If only the standard version is required, several components can be omitted (in particular, T3...T6 and P2).

10a

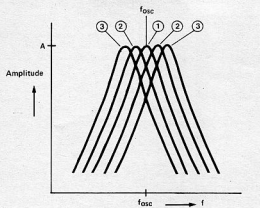

9948-10a

10b

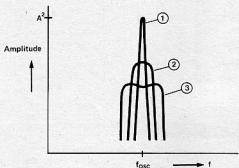

9948-10b

$$A = \frac{R8 + R9}{R9}$$

$$Q = R5 \sqrt{\frac{R8}{R9} \cdot \frac{C1}{C2} \cdot \frac{1}{R6 \cdot R7}}$$

If $C1 = C2 = C$, $R8 = R9$, $R5 = RQ$ and $R6 = R7 = R$, then:

$$f_0 = \frac{1}{2\pi RC} \quad A = 2 \quad Q = \frac{RQ}{R}$$

These equations are also true for the second filter (round IC4 and IC5). It is apparent from the expression for f_0 that (small) variations in centre frequencies of the two filters can be obtained by varying the value of one or more of resistors R8, R9, R13 and R14.

2. As far as the amplitude response of the selective filters used in this circuit is concerned, it can be shown that:

$$\frac{u_0^2}{u_i^2} = \frac{n^2}{(n^2 - 1)^2 + n^2 Q^2} \quad \text{where } u_i \text{ is the}$$

input voltage and u_0 the output voltage of the filter, and $n = \frac{f}{f_0}$.

If the Q of the filter is sufficiently

high, the above expression can be simplified to:

$$\frac{u_0^2}{u_i^2} = \frac{n}{(n^2 - 1) Q} \quad \text{for } n \gg 1$$

A symmetrical squarewave contains exclusively odd harmonics (this is in addition to the fundamental,

which is $\frac{4}{\pi}$ x the amplitude of the squarewave), i.e. $n = 3, 5, 7$ etc.

The amplitude of the n -th harmonic is $\frac{1}{n}$ x the fundamental. The amplitude of the third harmonic of a symmetrical squarewave is therefore $33 \frac{1}{3}\%$ that of the fundamental, the fifth harmonic is 20% of the fundamental, the seventh harmonic is approx. 14%... and so on.

The Q of the filters shown in figure 2 is approx. 55. If the centre frequencies f_{01} and f_{02} of the two filters are identical (and equal to the resonant frequency, $f_{osc} = \sqrt{f_{01} \cdot f_{02}}$), then a single filter will suppress the third harmonic by a factor of 146, the fifth harmonic by a factor of 264, and so on. With two filters connected in cascade, these factors should be squared. In actual fact the filters are fed not with a perfect squarewave, but with

11

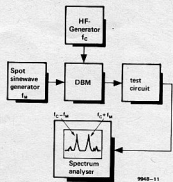

9948-11

Figures 10a and 10b. The effect of discrepancies between the centre frequencies of the two filters upon the combined amplitude response.

Figure 11. How the spot sinewave generator can be used to measure the intermodulation distortion of r.f. amplifiers.

a trapezoidal waveform, whose harmonics are less pronounced than those of a squarewave.

3. It can be shown that, with two bandpass filters connected in cascade, which have resonant frequencies of f_{01} and f_{02} , respectively, but which have the same resonant gain and quality factor, Q , that, at the frequency $\sqrt{f_{01} \cdot f_{02}}$, where $f_{02} > f_{01}$, the gain will fall by a factor of $1 + (Q \frac{1-x^2}{x})$, where $x = \sqrt{\frac{f_{02}}{f_{01}}}$.

If, as a result of component tolerances, f_{01} and f_{02} vary from one another by more than 10% ($x \approx 1.05$, $x^2 = 1.1$), and if $Q = 55$, then the gain of the two filters at the oscillator frequency will be reduced by a factor of 28.4. For this reason it is important that, as far as possible, one should attempt to match the components used in the two filters.

UNIVERSAL MULTIPLEXER

A fast, analogue and digital compatible, 16-channel multiplexer with provisions for manual and computer control. The circuit is offered as a design idea, and should find applications in test, measurement and instrumentation equipment.

The circuit described here is essentially an electronic 16-way rotary switch. It is composed of 2 functional sections: one takes care of the connection between the selected input channel and the "pole" of the 16-way switch, i.e., the output of the circuit, while the other provides the control signals necessary to select a particular channel from the 16 available. The control section accepts manual as well as computer or automatically generated channel selection codes. Applications of the universal multiplexer include quasi-simultaneous temperature measurement in a network of sensors mounted in different locations, controlled capturing of signals from strain gauges, light sensors or transducers, and the routing of command signals and voltages in automated test, measurement and production systems.

Manual or automatic control

In the manual mode, the desired channel is selected by the user pressing the channel increment key as many times as required. In the automatic mode, an oscillator provides the channel increment pulses. With reference to the circuit diagram of Fig. 1, the user selects between manual and automatic channel increment pulses with the aid of toggle switch S₁. This supplies a clock pulse to bistable FF₁ via set-reset bistable IC_{11a}, whose Q and \bar{Q} outputs toggle on each rising edge of the CLK signal. Thus, each time S₁ is pressed, the multiplexer changes between manual and automatic channel control, or vice versa. LEDs D₁₇ and D₁₈ indicate the currently selected mode. On power up, network R₁-C₁ at the SET input of FF₁ selects manual channel increment pulses. These are generated by S₂ and S-R bistable IC_{11a}, which functions as a debounce circuit. AND gate N₆ blocks the manual channel increment pulses when the unit is set to the automatic mode. Similarly, N_{3a} prevents the channel increment pulses from oscillator IC₄ being applied to pin 1 of N₂ in the manual mode. The oscillator pulses are only used in the automatic channel increment mode, that is, when \bar{Q} of FF₁ is logic high. The output frequency of the oscillator set up around IC₄ is adjustable to enable the channel increment speed being set as required for the application in question.

The channel increment pulses are not

routed direct to the switching section: AND gate N₅ effectively blocks them when the microprocessor or microcomputer holds circuit input $\mu P/\overline{MAN}$ logic high. In that case, LED D₁₉ lights to indicate that the increment pulses originate from the computer, and are applied to the CLK input of binary counter IC₁ via N₃ and N_{4b}. The clock pulses received by IC₁ increment the 4-bit binary value at outputs QA...QD. LED D₂₀ indicates the presence and the relative speed of the received or internally generated clockpulses.

Computer control

So far, the circuit description suggests that channel selection in the multiplexer is sequential and unidirectional. This means that if, for example, channel 3 is currently selected, the next channel can only be number 4, making it is impossible to step back to, say, channel 2, or on to 5 with a single clock pulse. This restriction was found unacceptable, so that the circuit was extended to enable the direct selection of any 1 of the 16 channels via input lines D₀...D₃, which control counter inputs A...D direct. When the computer's output port applies a logic high level to inputs $\mu P/\overline{MAN}$ and LOAD, pin 1 of IC₁ goes high, so that the binary value on D₀...D₃ is transferred to QA...QD. The control of input lines D₀...D₃,

$\mu P/\overline{MAN}$ and LOAD is within every programmer's reach when the appropriate data is sent to the computer's parallel output port (e.g. the Centronics outlet) with the aid of a simple BASIC program or (machine language) subroutine. The use of computer control on the proposed multiplexer makes it possible to activate any 1 of 16 (2⁴) channels at any time. This is in contrast to the sequential and unidirectional channel selection in the manual (automatic or switch-controlled) mode.

The 4 DIP switches marked RESET in the circuit diagram determine the last (highest) channel that can be activated. Four-bit comparator IC₃ compares the number of the selected channel to the configuration of the DIP switches, i.e., to the number of the channel defined as the last one. Output A=B (signal RS) goes high when equal channel numbers are applied to the A_n and B_n inputs of IC₃. The LOAD input of counter IC₁ is activated, and inputs A...D read 0000 thanks to pull-down resistors R₂...R₅ incl. This resets the counter to output state nought.

The current channel number is indicated by 1 of 16 LEDs selected by 4-to-16 decoder IC₂. The channel code is also applied to display driver IC₁₆, which arranges for the decimal channel number to be shown on a 1½-digit common cathode display. It should be noted that binary input 0000 on the SAB3211

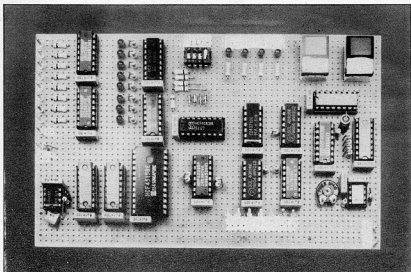

A prototype of the universal multiplexer built on a piece of veroboard.

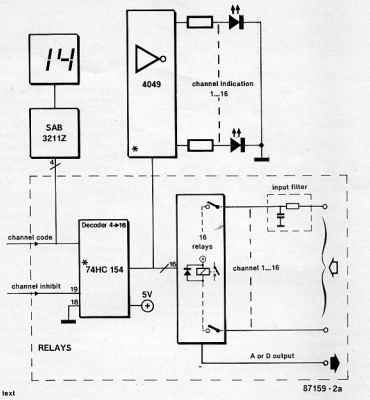

Fig. 2. Modifications to the multiplexer to enable the use of relays in the switching stage.

little power, they also have the advantage of being fast, silent, small, and inexpensive. They do not, however, allow the safe use of different potentials in the channel selection circuit (i.e., the multiplexer) and the circuit(s) driving the input lines. In applications where this is expected to

cause problems, it is recommended to ensure adequate insulation through the use of relays.

The multiplexed signal is buffered in operational amplifier ICs. This guarantees light loading of the selected channel, and a relatively low output impedance

for driving a wide variety of test equipment.

The analogue switches may be protected against static discharges by fitting 2 small-signal diodes on each input line. One diode is connected with its cathode to ground, and its anode to the input line; the other with its cathode to the positive supply voltage, and its anode to the input line.

Depending on the type of relay used, and the multiplexing speed, the inertia of the contacts may give rise to erroneous measurements owing to brief short-circuits between input channels. This is prevented by delay network R_2 - R_3 - C_6 freezing the output state of decoder IC: for about 10 ms in between 2 clock pulses. This ensures that the currently energized relay has enough time to complete opening its contacts before the next channel is selected.

The multiplexer can be fed from any supply voltage between 5 and 16 V, provided the series resistors for the LEDs and the display are dimensioned accordingly. Relays, as well as the 74HC154, require a supply of 5 V.

Finally, it should be noted that the circuit described is experimental: it can be extended as well as simplified to individual needs. The RESET configuration around IC: can be simplified by hard wiring the relevant inputs A_0 on the comparator; the $1\frac{1}{2}$ digit read-out can be set up around a display driver other than the SAB3211; the LEDs and associated driver ICs are optional; the number of channels can be reduced, and the gates used for the microprocessor interface may be omitted if computer control is not envisaged.

room thermometer

Using a National LM3911 IC, a 1 mA meter and a few resistors it is a simple matter to construct a thermometer to measure over the temperature range -20° to $+50^\circ\text{C}$, which should be adequate for all but polar climates! As the circuit is intended as a room thermometer the entire circuit operates at the temperature which is being measured, so the resistors used should be low-temperature coefficient types to maintain the accuracy of the circuit.

To calibrate the thermometer the meter scale must first be marked out linearly from zero = -20° to full-scale = $+50^\circ$. With P2 set to its mid-position the circuit should be placed in a freezer or the freezing compartment of a refrigerator set to -20°C and P1 should be adjusted until the meter reads -20 . The circuit should then be placed in a temperature of $+50^\circ\text{C}$ and P2 adjusted until the meter reads 50. Of course it is also possible to mark out the scale from 0°F to 120°F and calibrate zero and full-scale accordingly.

P1 and P2 interact to a small extent, so it may be necessary to repeat the procedure several times until both the -20 and $+50$ readings are accurate.

As the IC contains its own stabiliser the

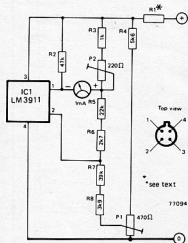

supply voltage is not critical provided the value of R_1 is chosen so that about 3 mA flows through it. The value of R_1 is given by $R_1 = \frac{V_b - 6}{3}$ (k Ω).

THE MEGAPHONE

Whether it is a sports event, or a police operation, or a demonstration, or a rally—the small funnel shaped gadget can be noticed, the MEGAPHONE.

The purpose of the megaphone is to make the human voice audible to a large crowd, upto a large distance. It replaces the public address system when portability is of prime importance. The sound quality is of secondary importance, as long as one can understand what is being announced. It is not expected to deliver Hi-Fi quality sound.

The circuit provided here is designed to deliver maximum possible power, without much attention to the frequency response and Hi-Fi quality. It will be very useful during your next bicycle tour or family picnic, or even the football match

How Does It Work?

Let's have a quick look at the circuit shown in figure 1. At the extreme left bottom corner, we have the microphone. Then the first stage of amplification—the transistor T1 in common emitter configuration. Its collector

current flows from the plus pole of the power supply, over the loudspeaker, R5, D1 and D2. R5 is the collector resistance, which converts the current amplification to voltage amplification. The collector voltage becomes the base voltage of the next transistor T2. The base voltage of T2 is just shifted by about 1.4 Volts by the two diodes D1 and D2. This is due to the fact that each diode drops about 0.7V. Thus the base voltage of T2 is 1.4V higher than the base voltage of T3, T2 T3 form the output amplifier stage. Both the emitters of T2 and T3 lie on

approximately half the supply voltage; which corresponds to the zero signal level. If the input is positive, then transistor T2 conducts and pulls the emitter terminal high. T3 remains blocked. When the input voltage goes negative, T3 conducts and T2 is blocked. In effect, what happens is that the negative parts of the input waveform are amplified by T3 and the positive parts of the input waveform are amplified by T2. The common emitter terminal of T2, and T3 is thus pulled high and low in the process.

As this is connected to the supply voltage through the capacitor C2 and the loud speaker, the AC current passes through the loud speaker, causing the input signal to be amplified and made audible through the loud speaker.

In technical language, this circuit is called the single ended push pull output stage. T2 and T3 are operating alternatively and the common emitter terminal is alternatively pulled up or pushed down. Hence the name 'Push-Pull' stage.

The two diodes D1 and D2 are very important for proper operation of the output stage.

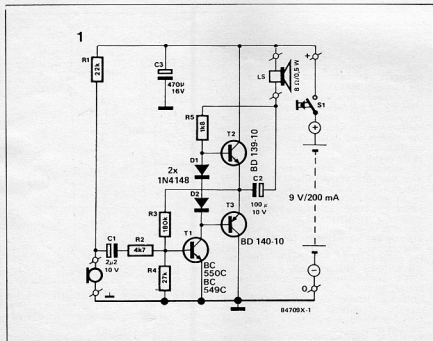

Figure 1:
A simple circuit for a megaphone which uses minimum number of components and gives a high power output.

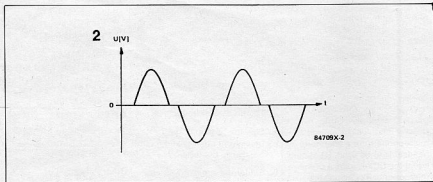

Figure 2 shows what would have happened in absence of D1 and D2. If the two bases were connected together directly, T2 would conduct only when the base voltage lies above the zero signal voltage by 0.7V. Similarly T3 would conduct only when it goes below the zero signal voltage by 0.7V. This would result in the output being distorted as shown in figure 2. The distortion is caused by the loss of input signal in the region of $\pm 0.7V$ around the zero signal.

The presence of D1 and D2 solve this problem by shifting the voltage levels.

The voltage at the common emitter terminals of T2 and T3 must lie halfway of the supply voltage. This is ensured by the two resistors R3 and R4. The ratio of these two resistors is 180:27, which is same as 4:0.6. We know that the threshold voltage of T1 is about 0.6 V. So in turn, the voltage across R3 must be 4V. This gives a voltage at the

common emitter terminal equal to 4.6 V, approximately half of the supply voltage. This voltage is stabilised by T1.

On the loud speaker, we have the AC voltage due to the coupling capacitor C2. This can swing between 0 to 9V depending on how strong the input signal is. If we connect on oscilloscope, we would effectively see that the voltage swing is between 4.5V DC to 13.5 DC (range still remains 9V). The circuit takes advantage

Figure 2:
Distortions that would have resulted in absence of diodes D1 and D2 in the circuit diagram of figure 1.

Figure 3:
Many things which are required to build the megaphone can be found in the junk room. The things required are as follows:

1. Measuring Beaker
2. Loud Speaker
3. Plastic Pipe
4. Aluminium Clamp
5. Switch.
6. PCB
7. Mounting Disc
8. Electret Microphone
9. Sponge disc
10. Cap
11. Fixing Screws.

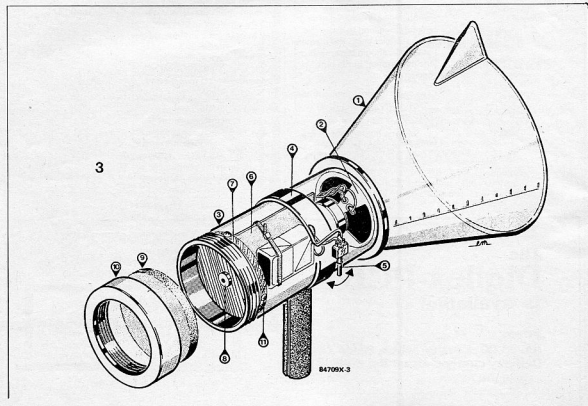

4

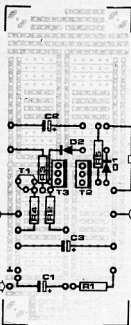

of this fact by connecting the collector resistance of T1 through the loud speaker.

This gives a larger amplification for T1, and makes our circuit more efficient.

For the microphone, an electret microphone is used, which obtains its supply over the resistor R1. In case a carbon microphone from a telephone handset is to be used, R1 should equal the DC resistance of the microphone. R2 decides the volume level. The output transformers must be of the same specified number, that is BD 139-10 and BD 140-10, to get good results.

TIPS FOR CONSTRUCTION:

Figure 3 shows a view of how the Megaphone can be constructed. A measuring beaker is used as the horn of the megaphone. (The manufacturer of the beaker would have never dreamt that it would be put to this use!) In addition to the beaker, a piece of plastic pipe is essential to fit the circuitry inside. A circular wooden disc is required to fix the microphone, and to avoid the acoustic feed back. The diameter of the disc should be same as the inside diameter of the pipe section.

The steps in construction of the megaphone are roughly as follows:

1. Saw the disc (7) and fix the microphone. The thickness of the disc should be about 5 mm. This will allow the fixing screws to take a firm grip.

2. The PCB and battery are then secured to the disc from other side.

3. Bore a hole for the on off switch (5) in the pipe. Connect sufficiently long wires to the switch.

4. Fix the disc (7) in the tube.

5. Saw the bottom of the measuring breaker and fix the breaker to the tube.

6. Solder the speaker wires to the speaker and fix the speaker firmly into the measuring breaker.

7. Fix the handle firmly to the pipe.

8. Fix a sponge disc over the microphone and fix a cap onto it. (10).

It is not necessary to follow these steps. One can use his own creative ideas to construct the megaphone.

After you have successfully built the megaphone and tried it out with the small 9V battery, you may have to get a shoulder bag for larger batteries and a connecting cord for the batteries. This is required if you must frequently use the megaphone for longer periods.

Figure 3 shows the simplest possible construction which can always be made more and more professional. As usual, the circuit is assembled on SELEX PCB size 1, as shown in the component layout of figure 4.

Figure 4:

Component layout.

Part list:

R1 = 22 K Ω R2 = 4.7 K Ω R3 = 180 K Ω R4 = 27 K Ω R5 = 1.8 K Ω
C1 = 2.2 μ F/10V C2 = 100 μ F/10V
C3 = 470 μ F/10V

D1, D2 = 1N 4148

T1 = BC 549C or BC 550C

T2 = BD 139 -10

T3 = BD 140-10

Other Parts:

S1 = On/Off toggle switch

1 Electret microphone

1 Loud Speaker Ω /0.5 W

1 SELEX PCB size 1

Various parts for construction, hook up wire etc.

The Digilex-PCB is available!

Price:

Rs. 85.00 + Maharashtra Sales Tax.

Delivery charges extra: Rs. 6.00

Send full amount by DD/MO/PO.

Available from:

precious[©]

ELECTRONICS CORPORATION

Journal Division

52-C, Proctor Road,

Bombay-400 007

Ph. 367459, 369478

Telex - (011) 76661 ELEK IN

NEW PRODUCTS • NEW PRODUCTS • N

Buzzer

This buzzer introduced by ION Electronics is an audio transducer, driven by an external oscillator. When driven by a 9 volts dc peak to peak square wave with 1 KHz frequency, IPB27M will produce an audible tone with sound pressure of at least 75 dB at a distance of 30 cm. The frequency response is fairly even over the range 200 Hz to 4 kHz.

The transducer is 27 mm in diameter and 5 mm in height. It is mounted on a plastic base measuring 30 x 30 mm. The IPB27M is ideally suited for small gadgets. Since the power required to drive it is small, IPB27M can be used in battery operated devices too.

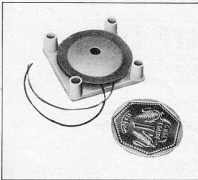

Typical applications of IPB27M are: Electronic Toys, Hobby Projects, Melody Generators, Metronomes, Telephone Tone Caller, Tweeters etc.

PROMOTION, • B1k # 4, Flr # 1, • 10, Subhash Cross Lane, • Bombay 400 057.

STRIP CHART RECORDER

With 32 channels every two seconds scan frequency, MOLYTEK'S 2702 is a fast multipoint strip chart recorder. The state of the art microprocessor technology has been used to pack a host of useful features into its compact size. The auto calibrating and auto scaling 2702 can accept any combination of thermocouple, RTD, voltage and current inputs. Specific type of inputs can be assigned to individual channels thru the keyboard. The thermal paper printing coupled with dot filling features provides sharp printing. Various parameters like chart speed, margins, channel information, alarm setpoints, relay logic, math functions etc. are all field programmable thru a typewriter like slide-in keyboard.



These parameters are retained in battery backed-up memory during the power down conditions. A battery backed up real time time clock keeps precise time and date for accurate records. 2702 comes with a standard RS-232 computer interface. Software is available to network upto 16 of 2702 units with one IBM-PC/XT giving a full fledged distributed data acquisition system.

JELTRON INSTRUMENTS (I) PVT. LTD.,

• 6-3-190/2, Road No. 1, • Banjara Hills
• Hyderabad 500 034. • Tel: 222411

Power Supply

Puneet Model DC-22 is an accurate and stable DC Power source with output varying from 0 to 30 V and current from 0 upto 20 Amps. It incorporates continuous current and voltage limiting. It has short circuit protection. This is a dual output supply which can be used in independent mode or tracking mode. Regulated power supplies with specific output voltage and current values are also made against specific enquiries.

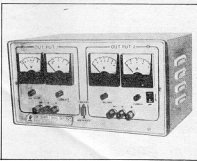

M/S. PUNEET INDUSTRIES,

• H-230, Ansa Industrial Estate,
• Saki-Vihar Road, • BOMBAY 400
072.

Milliohm Meter

Economy offers a digital Milliohm meter with a 3½ digit, 7 segment RED LED display, 5 ranges with lowest range of 200 milli ohm with 0.1 milli ohm resolution and highest range of 2 K ohm with 1 ohm resolution. Other ranges are 2 ohm, 20 ohm, 200 ohm. Selection is by interlocked push button switches. 4 wire measurement avoids lead resistance error. Accuracy of $\pm .05\%$ of range $\pm 0.1\%$ of reading ± 1 digit is reported.

Cabinet size: 247 mm Depth x 195 mm Width x 92mm Height. Weight: 2.5 kg.

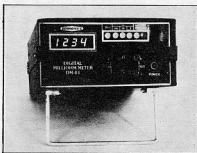

M/s. ECONOMY ELECTRONICS,

• 15, Sweet Home, Plot No. 442, • 2nd floor, Pitamber lane, • Off. Tulsii pipe road, Mahim, • Bombay 400 016.

Earth Sleeving

Suresh Electric & Electronics has developed Earth Sleeving, for use in electrical and electronic industries. The sleeves are manufactured in yellow colour with green stripe, and comply with international regulations for marking of single core cables and conductors. They are manufactured from plasticised P V C resistant to oils, ageing, light, ozone, acids and alkalis and can withstand temperature from -35°C to $+95^{\circ}\text{C}$.

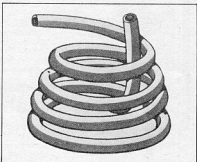

SURESH ELECTRICS & ELECTRONICS, • Post Box No. 9141, • Calcutta 700 016. • Phone: 29 0482, 29 5939.

NEW PRODUCTS • NEW PRODUCTS • N

Contactors

Larsen & Toubro Limited has introduced bar-type contactors which are specially designed for heavy duty under adverse conditions. These contactors, designed series N, are suitable for both AC and DC applications up to 1000 V and can withstand up to 600 operations per hour (Continuous) and up to 1200 operations per hour (occasional). Their DC2/3 ratings are equal to AC3 ratings and DC 4/5 ratings are equal to AC 4 ratings. They are available in AC3/DC3 ratings of 110A, 180A, 320A, 600A, 900A in various NO and NC pole combinations up to 4 poles.

L&T's bar-type contactors are available with accessories like mechanical interlock and a mechanical latch.

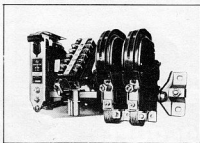

Larsen & Toubro Limited • Switchgear (S) Division • P O Box 278 • Bombay 400 038.

Digital Multimeters

Motwane have recently introduced, three handheld Digital Multimeters; model DM 452, a TRMS $4\frac{1}{2}$ digit and DM 352 & 350, both $3\frac{1}{2}$ digit. These multimeters are heavy duty, top of the line, 7 function, 28 range handheld, LCD readout, with shrouded leads and terminals.

All the three Multimeters have been developed indigenously.

Additional features are AC/DC currents upto 10A, Resistances upto 20M.ohm., continuity, conductance and diode testing, basic accuracy of 0.05% for the DM 452 with frequency response upto 10 KHz and 0.25% for the DM 352 and 350, these instruments, with help of probes can measure temperatures upto 1200°C, AC currents upto 600A, high voltages upto 40 KV AC/DC, frequencies upto 20 KHz and RF upto 200 MHz.

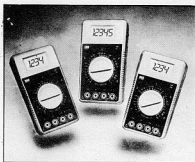

The Motwane Manufacturing Co Pvt. Ltd. • Gyan Ghar • Plot 434A • 14th Road • Khar • Bombay 400 052.

Temperature Transmitter

JNM's two-wire temperature transmitter is a design for 4-20mA current output suitable for various ranges of thermocouples, mV and RTD and has field adjustable zero and span with a turn down ratio of 3:1. The two wire concept helps to minimise the cable costs which is a great advantage. The output is current limited and upscale sensor fault indication is standard.

The RTD version features a built-in lineariser and the specified overall accuracy includes linearisation errors and having the output being linear with the input temperature signal.

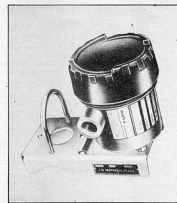

The transmitter has a removable PCB assembly housed in a weatherproof NEMA-4 enclosure. This arrangement reduces the installation, commissioning,

maintenance and inventory costs. This unit can be conveniently mounted on a pipe in a horizontal or vertical direction.

J.N. Marshall Pvt. Limited • P.B. No. 1 • Bombay - Pune Road • Kasarwadi • Pune-411 034.

Transformers

MAHAVIR INSTRUMENT TRANSFORMERS are manufactured and designed by SHEPHERD TRANSFORMERS. Applications are in ELECTRONIC ELECTRO-MECHANICAL AND ELECTRICAL INSTRUMENT EQUIPMENTS.

'MAHAVIR' Transformers are tested as per I.S. Specification for resistance, Voltage, No Load, On Load Open and Short Circuit, H.V. Humidity Heat Run etc. These transformers can also be supplied with Electro Static shield.

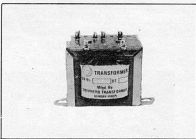

M/s. Shepherd Transformers • Nityanand Nagar • Off Link Bridge • Ghatkopar (West) • Bombay-400 086.

Fasteners

FTC offer a very wide range of fasteners to suit every requirement. Enquiries may be forwarded to.

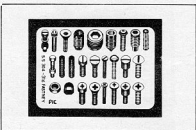

Forged & Turned Components • Marine House • Shop No F • 11-A, Navroji Hill Road • 93 Dr Maheshwari Road • P.B. No 5153 • Chinch Bunder • Bombay-400 009.

NEW PRODUCTS • NEW PRODUCTS • N

Wrist Strap

This personal grounding wrist strap is an essential part of static proofing the electronic work station for assembly workers and laboratory personnel. Protects sensitive devices from static charges generated by the operator.

This wrist strap is suitable for any size wrist. Coil cord has oxidation prevention, 6 ft., 360° swivel and high function resistor, strong grip banana plug and crocodile clip provide sure grounding.

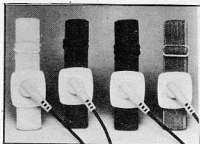

Davle Tech Inc. • 2-05 Banta Place • Fair Lawn • New Jersey-07410.

Storage Scope

With its maximum sampling rate of 100 MHz and a memory capacity of 10224 words, the Digital Storage Oscilloscope Bos is something special. A host of maths functions for signal processing and the IEC-bus interface (fitted as standard), make the handy BOS indispensable for both lab work and use in complex computer-controlled test systems.

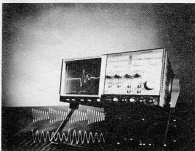

Rohde & Schwarz • Pressestelle • Mulhldorferstraße 15 • D-8000 München 80 • West Germany.

Power Mos

SGS has added two new transistors to its N-channel POWER MOS family. The MTP3055 and MTP3055AP are rated 60V (V_{DSS}) and 12A (I_D). The on-resistance, RDS(on) is as low as 0.15 ohm. Applications include series regulators, DC/DC converters and motor drives for industrial control equipment. Both transistors are produced using high density N-channel enhancement mode POWER MOS technology. Ultra high switching speed, low drive energy and low on-resistance are features which make these low cost devices ideal for very advanced, energy efficient, designs.

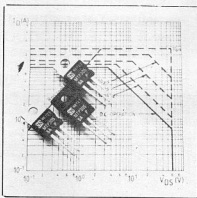

SGS Semiconductors (Pte) Ltd • 28 Ang Ko Kio Industrial Park-2 • Singapore-2056.

Light Source

ANDO of Japan offer the AQ 4137 & AQ 4141. Both instruments are multipurpose stabilised LD/LED light sources. The AQ 4137 can accommodate upto 2 channels while the AQ 4141 can accommodate upto 6 channels. Both LED and LD light source units of various wavelengths are available to allow many configurations with both AQ 4137 & AQ 4141. The AQ 4141 can automatically sweep each light source unit, a convenient feature for loss measurement of multichannel or multicore fibers. The plug in units are available for wavelengths 1310 nm, 1550 nm, 1300 nm, 850 nm and 660 nm for LED light and 1310 nm, 1550 nm and 850 nm for LD. All the units can putout CW light or 270 Hz chopped light. A high optical output of 3-dBm is available from the LD light and an external modulation of 0.3

to 100 KHz at TTL level can be performed on LD units. GP-IB is available as standard in both the instruments. Both the instruments can operate on AC mains as well as battery.

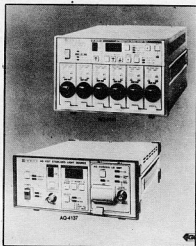

Murugappa Electronics Limited • 'Parry House' 3rd floor • 43 Moore Street • Madras 600 001.

Switch

Unique Electric Company introduces KS-30, a low profile snap action tactile feed back switch. This low stroke switch of 11.5 x 11.5 mm size is single pole, single throw, normally open type. Its design & low cost makes KS-30 a very economical switch ideally suited for applications like keyboards, Telephones, Microprocessor-based CNC machines & Instrumentation, Toys, Electronic instruments etc. The KS-30 snap action switch is also available with cap arrangement.

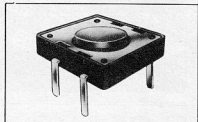

Unique Electric Company • B K Chhabra Compound • Vakola Bridge • Bulsroyce Lane • Santacruz (East) • Bombay 400 005.

Your Right Connection...

Champion

The Champion Connectors!

- o Dual In-line IC Sockets.
- o Single In-line IC Sockets.
- o Pin Grid Array Sockets.
- o Socket Adaptors.
- o Cage Jacks.

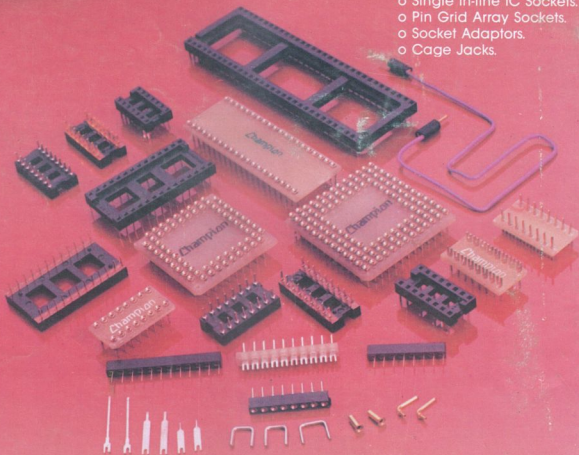

Champion Electronics. Pvt. Ltd.

S-17, M.I.D.C. Bhosari, Pune 411 026, India. (0212) 82682, 83791 Cable : CHAMPION
Telex: 0146-343 CHMP IN. 0145-333 MCCI IN. 0145-505 MCCI IN.